

GA-Z170X-SOC Force

User's Manual

Rev. 1001

12ME-Z17XSOF-1001R



For more product details, please visit GIGABYTE's website.



To reduce the impacts on global warming, the packaging materials of this product are recyclable and reusable. GIGABYTE works with you to protect the environment.

Declaration of Conformity

We, Manufacturer/Importer,

G.B.T. Technology Trading GmbH

Address: Bullenkoppel 16, 22047 Hamburg, Germany

Declare that the product

Product Type: **Motherboard**

Product Name: **GA-Z170X-SOC Force**

conforms with the essential requirements of the following directives:

2004/108/EC EMC Directive:

- Conduction & Radiated Emissions: EN 55022:2010
- Immunity: EN 55024:2010
- Power-line harmonics: EN 61000-3-2:2006+A2:2009
- Power-line flicker: EN 61000-3-3:2008

2006/95/EC LVD Directive

- Safety: EN60950-1:2006+A12:2011

2011/65/EU RoHS Directive

- Restriction of use of certain substances in electronic equipment: This product does not contain any of the restricted substances listed in Annex II, in concentrations and applications banned by the directive.

CE marking



Signature: Timmy Huang

(Name) Date: Sept. 18, 2015 Name: Timmy Huang

DECLARATION OF CONFORMITY

Per FCC Part 2 Section 2.1077(a)



Responsible Party Name: G.B.T. INC. (U.S.A.)

Address: 17358 Railroad Street

City of Industry, CA 91748

Phone/Fax No: (626) 854-9338/ (626) 854-9326

hereby declares that the product

Product Name: Motherboard

Model Number: GA-Z170X-SOC Force

Conforms to the following specifications:

FCC Part 15, Subpart B, Section 15.107(a) and Section 15.109

(a), Class B Digital Device

Supplementary Information:

This device complies with part 15 of the FCC Rules. Operation is subject to the following two conditions: (1) This device may not cause harmful and (2) this device must accept any interference received, including that may cause undesired operation.

Representative Person's Name: ERIC LU

Signature: Eric Lu

Date: Sept. 18, 2015

Copyright

© 2015 GIGA-BYTE TECHNOLOGY CO., LTD. All rights reserved.

The trademarks mentioned in this manual are legally registered to their respective owners.

Disclaimer

Information in this manual is protected by copyright laws and is the property of GIGABYTE. Changes to the specifications and features in this manual may be made by GIGABYTE without prior notice.

No part of this manual may be reproduced, copied, translated, transmitted, or published in any form or by any means without GIGABYTE's prior written permission.

Documentation Classifications

In order to assist in the use of this product, GIGABYTE provides the following types of documentations:

- For quick set-up of the product, read the Quick Installation Guide included with the product.
- For detailed product information, carefully read the User's Manual.

For product-related information, check on our website at: <http://www.gigabyte.com>

Identifying Your Motherboard Revision

The revision number on your motherboard looks like this: "REV: X.X." For example, "REV: 1.0" means the revision of the motherboard is 1.0. Check your motherboard revision before updating motherboard BIOS, drivers, or when looking for technical information.

Example:

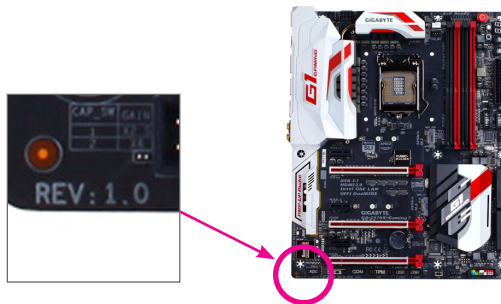

Table of Contents

Box Contents	6
Optional Items	6
GA-Z170X-SOC Force Motherboard Layout	7
Chapter 1 Hardware Installation	9
1-1 Installation Precautions	9
1-2 Product Specifications	10
1-3 Installing the CPU and CPU Cooler	14
1-3-1 Installing the CPU	14
1-3-2 Installing the CPU Cooler	16
1-4 Installing the Memory	17
1-4-1 Dual Channel Memory Configuration	17
1-4-2 Installing a Memory	18
1-5 Installing an Expansion Card	19
1-6 Setting up AMD CrossFire™/NVIDIA® SLI™ Configuration	20
1-7 Back Panel Connectors	22
1-8 Onboard Buttons, Switches, and LEDs	24
1-9 Internal Connectors	27
Chapter 2 BIOS Setup	41
2-1 Startup Screen	42
2-2 The Main Menu	43
2-3 M.I.T.	45
2-4 System Information	58
2-5 BIOS Features	59
2-6 Peripherals	62
2-7 Chipset	65
2-8 Power Management	66
2-9 Save & Exit	68
Chapter 3 Configuring a RAID Set	69
3-1 Configuring SATA Controllers	69
3-2 Installing the SATA RAID/AHCI Driver and Operating System	81
Chapter 4 Drivers Installation	85
4-1 Drivers & Software	85
4-2 Application Software	86
4-3 Information	86

Chapter 5 Unique Features.....	87
5-1 BIOS Update Utilities	87
5-1-1 Updating the BIOS with the Q-Flash Utility.....	87
5-1-2 Updating the BIOS with the @BIOS Utility	90
5-1-3 Using Q-Flash Plus.....	91
5-1-4 Using GIGABYTE HW OC.....	92
5-2 APP Center	93
5-2-1 EasyTune.....	94
5-2-2 System Information Viewer.....	95
5-2-3 Fast Boot	96
5-2-4 Smart TimeLock.....	97
5-2-5 USB Blocker	98
5-2-6 Smart Keyboard.....	99
5-2-7 Smart Backup	100
5-2-8 Ambient LED	102
5-2-9 3D OSD	103
5-2-10 Cloud Station.....	104
5-2-11 AutoGreen	109
5-2-12 Easy RAID	110
5-3 Smart Switch	113
Chapter 6 Appendix.....	115
6-1 Configuring Audio Input and Output	115
6-1-1 Configuring 2/4/5.1/7.1-Channel Audio.....	115
6-1-2 Configuring S/PDIF Out.....	117
6-1-3 Configuring Microphone Recording	118
6-1-4 Using the Sound Recorder	120
6-2 Troubleshooting.....	121
6-2-1 Frequently Asked Questions	121
6-2-2 Troubleshooting Procedure	122
6-3 Debug LED Codes	124
Regulatory Statements.....	128
Contact Us	131

Box Contents

- GA-Z170X-SOC Force motherboard
- Motherboard driver disk
- User's Manual
- Quick Installation Guide
- Four SATA cables
- I/O Shield
- One 2-Way SLI bridge connector
- One 3-Way SLI bridge connector
- One 4-Way SLI bridge connector
- One 2-Way CrossFire bridge connector
- Eight voltage measurement cables
- One OC Brace
- One G Connector
- One pack of back I/O dust covers

The box contents above are for reference only and the actual items shall depend on the product package you obtain. The box contents are subject to change without notice.

Optional Items

- 2-port USB 2.0 bracket (Part No. 12CR1-1UB030-6*R)
- eSATA bracket (Part No. 12CF1-3SATPW-4*R)
- 3.5" Front Panel with 2 USB 3.0/2.0 ports (Part No. 12CR1-FPX582-2*R)
- HDMI-to-DVI adapter (Part No. 12CT2-HDMI01-1*R)
- COM port cable (Part No. 12CF1-1CM001-3*R)

GA-Z170X-SOC Force Motherboard Layout

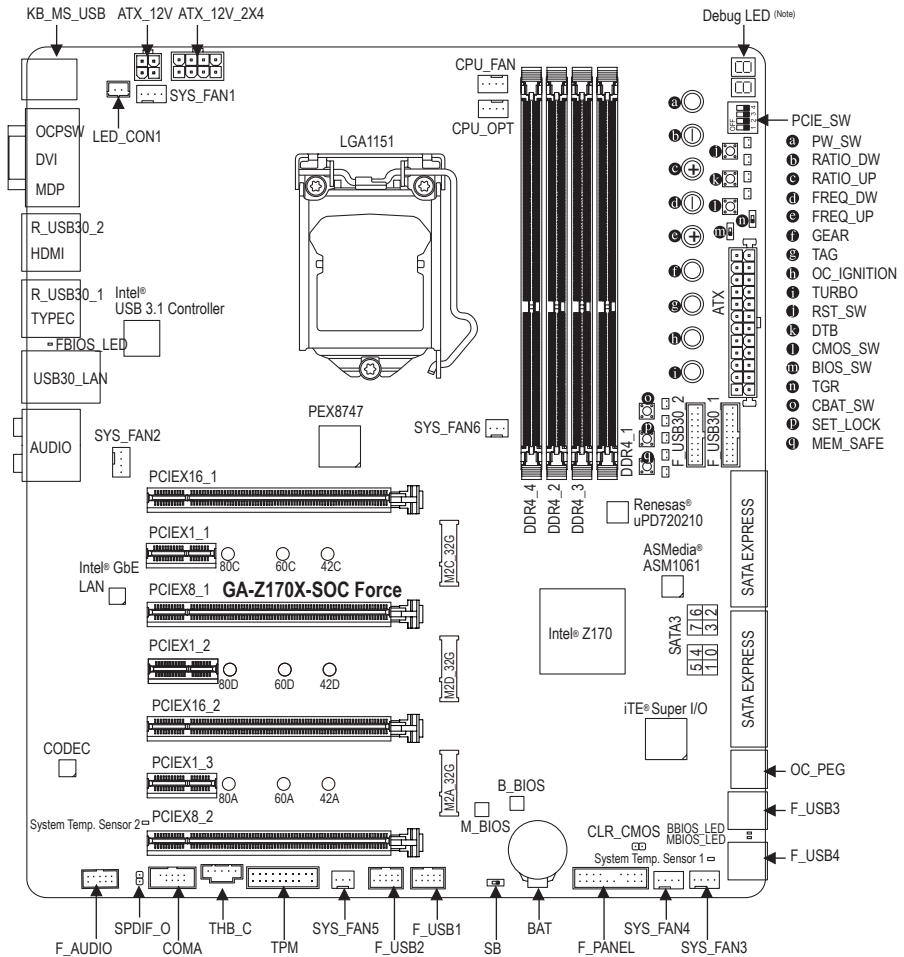

(Note) For debug code information, please refer to Chapter 6.









Chapter 1 Hardware Installation



1-1 Installation Precautions







The motherboard contains numerous delicate electronic circuits and components which can become damaged as a result of electrostatic discharge (ESD). Prior to installation, carefully read the user's manual and follow these procedures:

- Prior to installation, make sure the chassis is suitable for the motherboard.
- Prior to installation, do not remove or break motherboard S/N (Serial Number) sticker or warranty sticker provided by your dealer. These stickers are required for warranty validation.
- Always remove the AC power by unplugging the power cord from the power outlet before installing or removing the motherboard or other hardware components.
- When connecting hardware components to the internal connectors on the motherboard, make sure they are connected tightly and securely.
- When handling the motherboard, avoid touching any metal leads or connectors.
- It is best to wear an electrostatic discharge (ESD) wrist strap when handling electronic components such as a motherboard, CPU or memory. If you do not have an ESD wrist strap, keep your hands dry and first touch a metal object to eliminate static electricity.
- Prior to installing the motherboard, please have it on top of an antistatic pad or within an electrostatic shielding container.
- Before connecting or unplugging the power supply cable from the motherboard, make sure the power supply has been turned off.
- Before turning on the power, make sure the power supply voltage has been set according to the local voltage standard.
- Before using the product, please verify that all cables and power connectors of your hardware components are connected.
- To prevent damage to the motherboard, do not allow screws to come in contact with the motherboard circuit or its components.
- Make sure there are no leftover screws or metal components placed on the motherboard or within the computer casing.
- Do not place the computer system on an uneven surface.
- Do not place the computer system in a high-temperature or wet environment.
- Turning on the computer power during the installation process can lead to damage to system components as well as physical harm to the user.
- If you are uncertain about any installation steps or have a problem related to the use of the product, please consult a certified computer technician.
- If you use an adapter, extension power cable, or power strip, ensure to consult with its installation and/or grounding instructions.

1-2 Product Specifications

	CPU	<ul style="list-style-type: none"> ◆ Support for Intel® Core™ i7 processors/Intel® Core™ i5 processors/Intel® Core™ i3 processors/Intel® Pentium® processors/Intel® Celeron® processors in the LGA1151 package (Go to GIGABYTE's website for the latest CPU support list.) ◆ L3 cache varies with CPU
	Chipset	<ul style="list-style-type: none"> ◆ Intel® Z170 Express Chipset
	Memory	<ul style="list-style-type: none"> ◆ 4 x DDR4 DIMM sockets supporting up to 64 GB of system memory <ul style="list-style-type: none"> * Due to a Windows 32-bit operating system limitation, when more than 4 GB of physical memory is installed, the actual memory size displayed will be less than the size of the physical memory installed. ◆ Dual channel memory architecture ◆ Support for DDR4 2133 MHz memory modules ◆ Support for ECC UDIMM 1Rx8/2Rx8 memory modules (operate in non-ECC mode) ◆ Support for non-ECC UDIMM 1Rx8/2Rx8/1Rx16 memory modules ◆ Support for Extreme Memory Profile (XMP) memory modules (Go to GIGABYTE's website for the latest supported memory speeds and memory modules.)
	Onboard Graphics	<ul style="list-style-type: none"> ◆ Integrated Graphics Processor-Intel® HD Graphics support: <ul style="list-style-type: none"> - 1 x DVI-D port, supporting a maximum resolution of 1920x1200@60 Hz <ul style="list-style-type: none"> * The DVI-D port does not support D-Sub connection by adapter. - 1 x Mini-DisplayPort, supporting a maximum resolution of 4096x2304@60 Hz <ul style="list-style-type: none"> * Support for DisplayPort 1.2 version. - 1 x HDMI port, supporting a maximum resolution of 4096x2160@24 Hz <ul style="list-style-type: none"> * Support for HDMI 1.4 version. ◆ Support for up to 3 displays at the same time ◆ Maximum shared memory of 512 MB
	Audio	<ul style="list-style-type: none"> ◆ Realtek® ALC1150 codec ◆ High Definition Audio ◆ 2/4/5.1/7.1-channel ◆ Support for S/PDIF Out
	LAN	<ul style="list-style-type: none"> ◆ Intel® GbE LAN chip (10/100/1000 Mbit)
	Expansion Slots	<ul style="list-style-type: none"> ◆ 2 x PCI Express x16 slots, running at x16 (PCIEX16_1, PCIEX16_2) <ul style="list-style-type: none"> * For optimum performance, if only one PCI Express graphics card is to be installed, be sure to install it in the PCIEX16_1 slot; if you are installing two PCI Express graphics cards, it is recommended that you install them in the PCIEX16_1 and PCIEX16_2 slots. ◆ 2 x PCI Express x16 slots, running at x8 (PCIEX8_1, PCIEX8_2) <ul style="list-style-type: none"> * The PCIEX8_1 slot shares bandwidth with the PCIEX16_1 slot and the PCIEX8_2 slot with PCIEX16_2. The PCIEX16_1/PCIEX16_2 slot will operate at up to x8 mode when the PCIEX8_1/PCIEX8_2 is populated. ◆ 3 x PCI Express x1 slots (All of the PCI Express slots conform to PCI Express 3.0 standard.)
	Multi-Graphics Technology	<ul style="list-style-type: none"> ◆ Support for 4-Way/3-Way/2-Way AMD CrossFire™/NVIDIA® SLI™ technology

	Storage Interface	<ul style="list-style-type: none"> ◆ Chipset: <ul style="list-style-type: none"> - 3 x M.2 Socket 3 connectors - 3 x SATA Express connectors - 6 x SATA 6Gb/s connectors (SATA3 0~5) - Support for RAID 0, RAID 1, RAID 5, and RAID 10 <ul style="list-style-type: none"> * Refer to "1-9 Internal Connectors," for the supported configurations with the M.2, SATA Express, and SATA connectors. ◆ ASMedia® ASM1061 chip: <ul style="list-style-type: none"> - 2 x SATA 6Gb/s connectors (SATA3 6~7), supporting AHCI mode only
	USB	<ul style="list-style-type: none"> ◆ Chipset+Intel® USB 3.1 Controller: <ul style="list-style-type: none"> - 1 x USB Type-C™ port on the back panel, with USB 3.1 support - 1 x USB 3.1 port on the back panel ◆ Chipset: <ul style="list-style-type: none"> - 5 x USB 3.0/2.0 ports on the back panel - 8 x USB 2.0/1.1 ports (2 ports on the back panel, 2 ports onboard, 4 ports available through the internal USB headers) ◆ Chipset+Renesas® USB 3.0 Hub: <ul style="list-style-type: none"> - 4 x USB 3.0/2.0 ports (available through the internal USB headers)
	Internal Connectors	<ul style="list-style-type: none"> ◆ 1 x 24-pin ATX main power connector ◆ 1 x 8-pin ATX 12V power connector ◆ 1 x 4-pin ATX 12V power connector ◆ 1 x OC PEG Power Connector ◆ 3 x SATA Express connectors ◆ 8 x SATA 6Gb/s connectors ◆ 3 x M.2 Socket 3 connectors ◆ 1 x CPU fan header ◆ 1 x water cooling fan header (CPU_OPT) ◆ 6 x system fan headers ◆ 1 x I/O shield audio LED power connector ◆ 1 x Thunderbolt™ add-in card connector ◆ 1 x front panel header ◆ 1 x front panel audio header ◆ 1 x S/PDIF Out header ◆ 2 x USB 3.0/2.0 headers ◆ 2 x USB 2.0/1.1 headers ◆ 2 x USB 2.0/1.1 ports ◆ 1 x Trusted Platform Module (TPM) header ◆ 1 x serial port header ◆ 1 x Clear CMOS jumper ◆ 1 x power button ◆ 1 x reset button ◆ 1 x Clear CMOS button ◆ 1 x Gear button ◆ 1 x OC Tag button ◆ 1 x OC Trigger switch ◆ 1 x CPU BCLK Down button ◆ 1 x CPU BCLK Up button ◆ 1 x CPU Ratio Down button

	Internal Connectors	<ul style="list-style-type: none"> ◆ 1 x CPU Ratio Up button ◆ 1 x Settings Lock button ◆ 1 x Direct to BIOS button ◆ 1 x Memory Safe button ◆ 1 x OC PCIe switch ◆ 1 x OC Ignition button ◆ 1 x Clear Battery button ◆ 1 x DualBIOS switch ◆ 1 x BIOS switch ◆ 1 x onboard voltage measurement module
	Back Panel Connectors	<ul style="list-style-type: none"> ◆ 2 x USB 2.0/1.1 ports ◆ 1 x PS/2 keyboard/mouse port ◆ 1 x DVI-D port ◆ 1 x OCPSW button ◆ 1 x Mini-DisplayPort ◆ 1 x HDMI port ◆ 5 x USB 3.0/2.0 ports ◆ 1 x USB Type-C™ port, with USB 3.1 support ◆ 1 x USB 3.1 port ◆ 1 x RJ-45 port ◆ 1 x optical S/PDIF Out connector ◆ 5 x audio jacks (Center/Subwoofer Speaker Out, Rear Speaker Out, Line In, Line Out, Mic In)
	I/O Controller	<ul style="list-style-type: none"> ◆ iTE I/O Controller Chip
	Hardware Monitor	<ul style="list-style-type: none"> ◆ System voltage detection ◆ CPU/System/Chipset temperature detection ◆ CPU/CPU OPT/System fan speed detection ◆ CPU/System/Chipset overheating warning ◆ CPU/CPU OPT/System fan fail warning ◆ CPU/CPU OPT/System fan speed control <ul style="list-style-type: none"> * Whether the fan speed control function is supported will depend on the cooler you install.
	BIOS	<ul style="list-style-type: none"> ◆ 2 x 128 Mbit flash ◆ Use of licensed AMI UEFI BIOS ◆ Support for DualBIOS™ ◆ Support for Q-Flash Plus <ul style="list-style-type: none"> * The USB flash drive used must be a USB 2.0 flash drive. ◆ PnP 1.0a, DMI 2.7, WfM 2.0, SM BIOS 2.7, ACPI 5.0
	Unique Features	<ul style="list-style-type: none"> ◆ Support for APP Center <ul style="list-style-type: none"> * Available applications in APP Center may vary by motherboard model. Supported functions of each application may also vary depending on motherboard specifications. - 3D OSD - @BIOS - Ambient LED - AutoGreen - Cloud Station - EasyTune - Easy RAID

★	Unique Features	<ul style="list-style-type: none"> - Fast Boot - Smart TimeLock - Smart Keyboard - Smart Backup - System Information Viewer - USB Blocker ◆ Support for Q-Flash ◆ Support for Smart Switch ◆ Support for Xpress Install ◆ Support for GIGABYTE HW OC <ul style="list-style-type: none"> * Please download the app from Google Play or App Store to your smart phone/tablet device.
📁	Bundled Software	<ul style="list-style-type: none"> ◆ Norton® Internet Security (OEM version) ◆ Intel® Smart Response Technology ◆ cFosSpeed
⚙️	Operating System	<ul style="list-style-type: none"> ◆ Support for Windows 10/8.1/7 <ul style="list-style-type: none"> * Please download the "Windows USB Installation Tool" from GIGABYTE's website and install it before installing Windows 7.
📏	Form Factor	<ul style="list-style-type: none"> ◆ E-ATX Form Factor; 30.5cm x 26.4cm

* GIGABYTE reserves the right to make any changes to the product specifications and product-related information without prior notice.



Please visit GIGABYTE's website for support lists of CPU, memory modules, SSDs, and M.2 devices.



Please visit the **SupportUtility List** page on GIGABYTE's website to download the latest version of apps.

1-3 Installing the CPU and CPU Cooler



Read the following guidelines before you begin to install the CPU:

- Make sure that the motherboard supports the CPU.
(Go to GIGABYTE's website for the latest CPU support list.)
- Always turn off the computer and unplug the power cord from the power outlet before installing the CPU to prevent hardware damage.
- Locate the pin one of the CPU. The CPU cannot be inserted if oriented incorrectly. (Or you may locate the notches on both sides of the CPU and alignment keys on the CPU socket.)
- Apply an even and thin layer of thermal grease on the surface of the CPU.
- Do not turn on the computer if the CPU cooler is not installed, otherwise overheating and damage of the CPU may occur.
- Set the CPU host frequency in accordance with the CPU specifications. It is not recommended that the system bus frequency be set beyond hardware specifications since it does not meet the standard requirements for the peripherals. If you wish to set the frequency beyond the standard specifications, please do so according to your hardware specifications including the CPU, graphics card, memory, hard drive, etc.

1-3-1 Installing the CPU

- A. Locate the alignment keys on the motherboard CPU socket and the notches on the CPU.

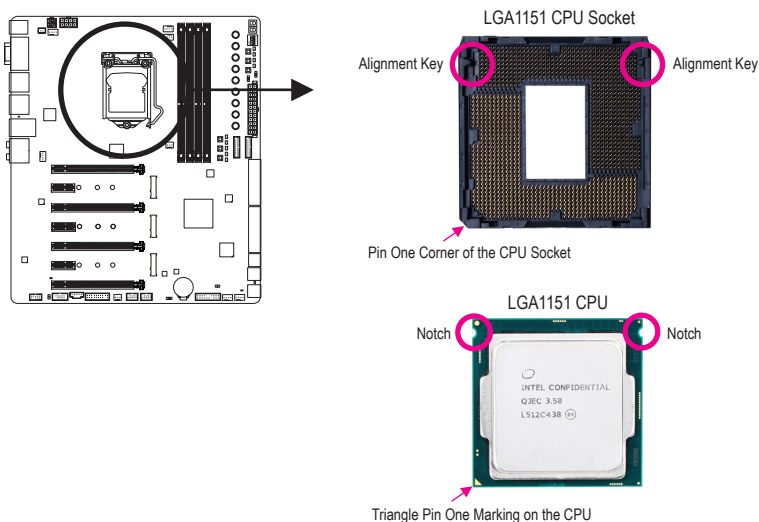

Please visit GIGABYTE's website for details on hardware installation.

B. Follow the steps below to correctly install the CPU into the motherboard CPU socket.



- Before installing the CPU, make sure to turn off the computer and unplug the power cord from the power outlet to prevent damage to the CPU.
- To protect the socket contacts, do not remove the protective plastic cover unless the CPU is inserted into the CPU socket. Save the cover properly and replace it if the CPU is removed.

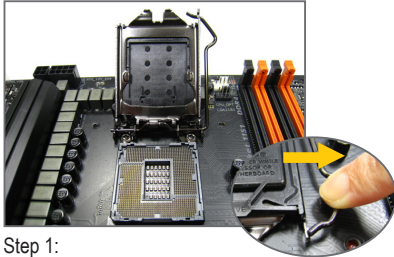

Step 1:
Gently press the CPU socket lever handle down and away from the socket with your finger. Then completely lift the CPU socket lever and the metal load plate/plastic cover will be lifted as well.



Step 2:
Hold the CPU with your thumb and index fingers. Align the CPU pin one marking (triangle) with the pin one corner of the CPU socket (or you may align the CPU notches with the socket alignment keys) and gently insert the CPU into position.



Step 3:
Once the CPU is properly inserted, carefully replace the load plate. When replacing the load plate, make sure the front end of the load plate is under the shoulder screw. Then press the CPU socket lever. The protective plastic cover may pop off from the load plate during the process of engaging the lever. Remove the cover. (Save the cover properly and always replace it when the CPU is not installed.)



Step 4:
Finally, secure the lever under its retention tab to complete the installation of the CPU.

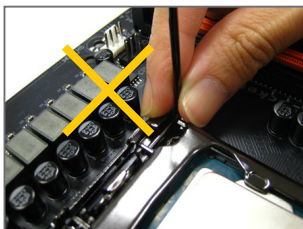

NOTE:

Hold the CPU socket lever by the handle, not the lever base portion.

1-3-2 Installing the CPU Cooler

Refer to the steps below to correctly install the CPU cooler on the motherboard. (Actual installation process may differ depending the CPU cooler to be used. Refer to the user's manual for your CPU cooler.)



Step 1:
Apply an even and thin layer of thermal grease on the surface of the installed CPU.

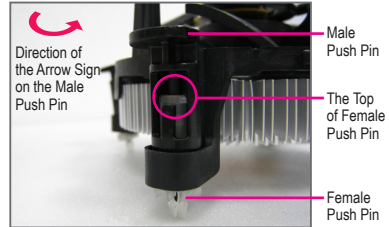

Step 2:
Before installing the cooler, note the direction of the arrow sign  on the male push pin. (Turning the push pin along the direction of arrow is to remove the cooler, on the contrary, is to install.)

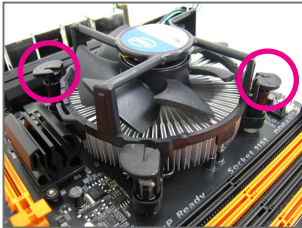

Step 3:
Place the cooler atop the CPU, aligning the four push pins through the pin holes on the motherboard. Push down on the push pins diagonally.

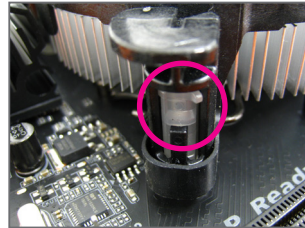

Step 4:
You should hear a "click" when pushing down each push pin. Check that the Male and Female push pins are joined closely. (Refer to your CPU cooler installation manual for instructions on installing the cooler.)



Step 5:
After the installation, check the back of the motherboard. If the push pin is inserted as the picture above shows, the installation is complete.

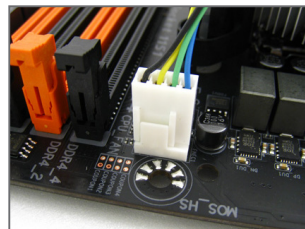

Step 6:
Finally, attach the power connector of the CPU cooler to the CPU fan header (CPU_FAN) on the motherboard.



- Use extreme care when removing the CPU cooler because the thermal grease/tape between the CPU cooler and CPU may adhere to the CPU. Inadequately removing the CPU cooler may damage the CPU.
- This motherboard provides two G1/4" threaded fittings. Please choose the barbs (not included) that suit your requirements.

1-4 Installing the Memory



Read the following guidelines before you begin to install the memory:

- Make sure that the motherboard supports the memory. It is recommended that memory of the same capacity, brand, speed, and chips be used.
(Go to GIGABYTE's website for the latest supported memory speeds and memory modules.)
- Always turn off the computer and unplug the power cord from the power outlet before installing the memory to prevent hardware damage.
- Memory modules have a foolproof design. A memory module can be installed in only one direction. If you are unable to insert the memory, switch the direction.

1-4-1 Dual Channel Memory Configuration

This motherboard provides four memory sockets and supports Dual Channel Technology. After the memory is installed, the BIOS will automatically detect the specifications and capacity of the memory. Enabling Dual Channel memory mode will double the original memory bandwidth.

The four memory sockets are divided into two channels and each channel has two memory sockets as following:

▶▶ Channel A: DDR4_2, DDR4_4

▶▶ Channel B: DDR4_1, DDR4_3

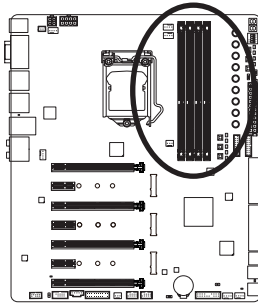

▶▶ Dual Channel Memory Configurations Table

	DDR4_4	DDR4_2	DDR4_3	DDR4_1
2 Modules	--	DS/SS	--	DS/SS
	DS/SS	--	DS/SS	--
4 Modules	DS/SS	DS/SS	DS/SS	DS/SS

(SS=Single-Sided, DS=Double-Sided, "--"=No Memory)

Due to CPU limitations, read the following guidelines before installing the memory in Dual Channel mode.

1. Dual Channel mode cannot be enabled if only one memory module is installed.
2. When enabling Dual Channel mode with two or four memory modules, it is recommended that memory of the same capacity, brand, speed, and chips be used and installed in the same colored sockets.

1-4-2 Installing a Memory

 Before installing a memory module, make sure to turn off the computer and unplug the power cord from the power outlet to prevent damage to the memory module. DDR4 and DDR3 DIMMs are not compatible to each other or DDR2 DIMMs. Be sure to install DDR4 DIMMs on this motherboard.

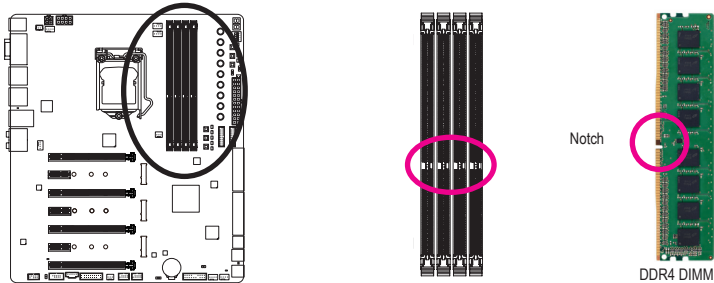

A DDR4 memory module has a notch, so it can only fit in one direction. Follow the steps below to correctly install your memory modules in the memory sockets.

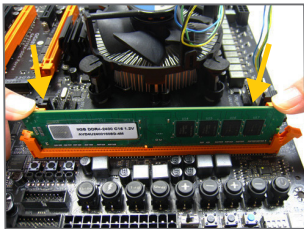

Step 1:

Note the orientation of the memory module. Spread the retaining clip at the right end of the memory socket. Place the memory module on the socket. As indicated in the picture on the left, place your fingers on the top edge of the memory, push down on the memory and insert it vertically into the memory socket.

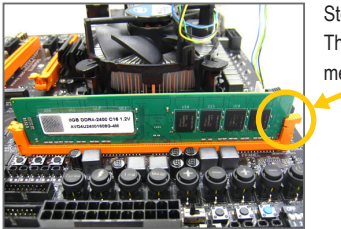

Step 2:

The clip at the right end of the socket will snap into place when the memory module is securely inserted.

1-5 Installing an Expansion Card



Read the following guidelines before you begin to install an expansion card:

- Make sure the motherboard supports the expansion card. Carefully read the manual that came with your expansion card.
- Always turn off the computer and unplug the power cord from the power outlet before installing an expansion card to prevent hardware damage.

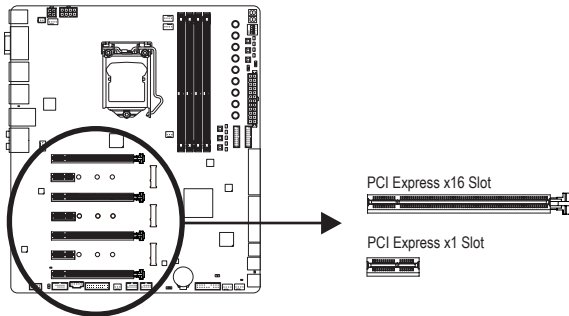

Follow the steps below to correctly install your expansion card in the expansion slot.

1. Locate an expansion slot that supports your card. Remove the metal slot cover from the chassis back panel.
2. Align the card with the slot, and press down on the card until it is fully seated in the slot.
3. Make sure the metal contacts on the card are completely inserted into the slot.
4. Secure the card's metal bracket to the chassis back panel with a screw.
5. After installing all expansion cards, replace the chassis cover(s).
6. Turn on your computer. If necessary, go to BIOS Setup to make any required BIOS changes for your expansion card(s).
7. Install the driver provided with the expansion card in your operating system.

Example: Installing and Removing a PCI Express Graphics Card:



- Installing a Graphics Card:
Gently push down on the top edge of the card until it is fully inserted into the PCI Express slot. Make sure the card is securely seated in the slot and does not rock.



- Removing the Card:
Gently push back on the lever on the slot and then lift the card straight out from the slot.

1-6 Setting up AMD CrossFire™/NVIDIA® SLI™ Configuration

A. System Requirements

- Windows 10/8.1/7 operating system
- A CrossFire/SLI-supported motherboard with two PCI Express x16 slots and correct driver
- CrossFire/SLI-ready graphics cards of identical brand and chip and correct driver (Current GPUs that support 3-Way/4-Way CrossFire technology include the ATI Radeon™ HD 3800, HD 4800, HD 5800 series, and AMD Radeon™ HD 6800, HD 6900, HD 7800, and HD 7900 series. Current GPUs that support 3-Way/4-Way SLI™ technology include the NVIDIA 8800 GTX, 8800 Ultra, 9800 GTX, GTX 260, GTX 280, GTX 470, GTX 480, GTX 570, GTX 580, GTX 590, and GTX 600 series.) For the latest GPU support information, please refer to the AMD/NVIDIA® website.)
- CrossFire^(Note 1)/SLI bridge connectors
- A power supply with sufficient power is recommended (Refer to the manual of your graphics cards for the power requirement)^(Note 2)

B. Connecting the Graphics Cards

Step 1:

Observe the steps in "1-5 Installing an Expansion Card" and install CrossFire/SLI graphics cards on the PCI Express x16 slots. (To set up a 2-Way configuration, we recommend installing the graphics cards in the PCIEX16_1 and PCIEX16_2 slots. To set up a 3-Way configuration, we recommend installing the graphics cards on the PCIEX16_1, PCIEX8_1, and PCIEX16_2 slots.)

Step 2:

Insert the CrossFire^(Note 1)/SLI bridge connectors in the CrossFire/SLI gold edge connectors on top of the cards.

Step 3:

Plug the display cable into the graphics card on the PCIEX16_1 slot.

C. Configuring the Graphics Card Driver

C-1. To Enable CrossFire Function

After installing the graphics card driver in the operating system, go to the **AMD Catalyst Control Center**. Browse to **Performance** and ensure the **Enable AMD CrossFireX** check box is selected. If your system has more than two CrossFire cards, select the GPU combination you want to use and click **Apply**. (Available combination options are dependent on the number of graphics cards.)

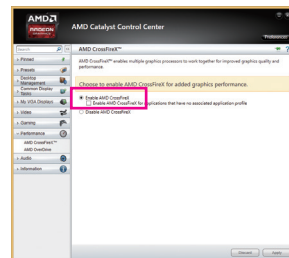

C-2. To Enable SLI Function

After installing the graphics card driver in the operating system, go to the **NVIDIA Control Panel**. Browse to the **Configure SLI, Surround, Physx** screen and ensure **Maximize 3D performance** is enabled.

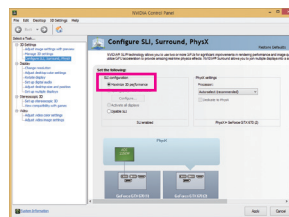

D. Installing the OC Brace^(Note 3)

OC Brace allows extreme overclockers and system testers to safely install up to four graphics cards in an open case or test bed without risking PCIe slot damage or preventing cards not showing up in the OS due to poor contact with PCIe slot. Refer to the following installation instructions:

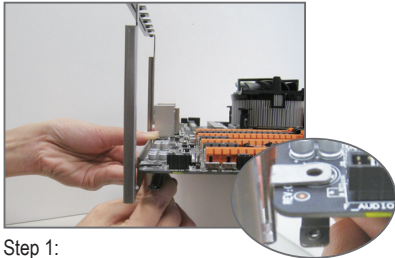

Step 1:

As shown, align the screw holes in the OC Brace and back plate with the screw holes near the PCIe slots on the motherboard.

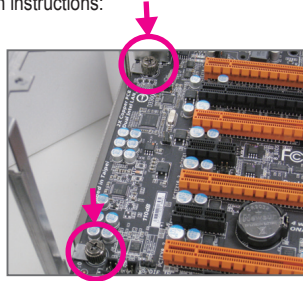

Step 2:

Fasten the two included thumb screws (starting from the screw hole near the back panel audio connectors).

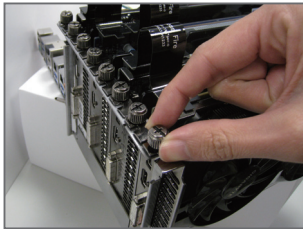

Step 3:

After installing the graphics cards, use the included thumb screws to secure the metal brackets of the graphics cards to the OC Brace.

(Note 1) The bridge connectors may be needed or not depending on your graphics cards.

(Note 2) When two or more graphics cards are installed, we recommend that you connect the power cable from the power supply to the OC_PEG connector to ensure system stability.

(Note 3) The components received may vary in appearance from the products illustrated.



Procedure and driver screen for enabling CrossFire/SLI technology may differ by graphics cards and driver version. Refer to the manual that came with your graphics cards for more information about enabling CrossFire/SLI technology.

1-7 Back Panel Connectors

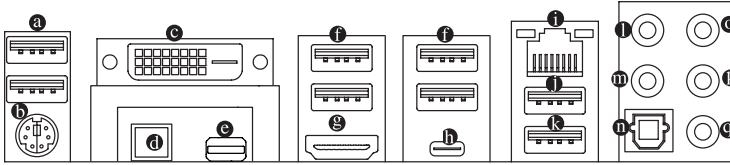

a USB 2.0/1.1 Port

The USB port supports the USB 2.0/1.1 specification. Use this port for USB devices.

b PS/2 Keyboard/Mouse Port

Use this port to connect a PS/2 mouse or keyboard.

c DVI-D Port (Note)

The DVI-D port conforms to the DVI-D specification and supports a maximum resolution of 1920x1200@60 Hz (the actual resolutions supported depend on the monitor being used). Connect a monitor that supports DVI-D connection to this port.

d OCPSW Button

This button allows you to use your smart phone/tablet device to overclock or monitor your computer with the GIGABYTE HW OC app. Refer to the instructions on using this feature in Chapter 5, "Using GIGABYTE HW OC."

e Mini-DisplayPort

DisplayPort delivers high quality digital imaging and audio, supporting bi-directional audio transmission. DisplayPort can support both DPCP and HDCP content protection mechanisms. You can use this port to connect your Mini-DisplayPort-supported monitor. The maximum supported resolution is 4096x2304@60 Hz, but the actual resolutions supported are dependent on the monitor being used.

f USB 3.0/2.0 Port

The USB 3.0 port supports the USB 3.0 specification and is compatible to the USB 2.0/1.1 specification. Use this port for USB devices.

g HDMI Port

HDMI™ The HDMI port is HDCP compliant and supports Dolby True HD and DTS HD Master Audio formats. It also supports up to 192 KHz/24bit 8-channel LPCM audio output. You can use this port to connect your HDMI-supported monitor. The maximum supported resolution is 4096x2160@24 Hz, but the actual resolutions supported are dependent on the monitor being used.



- To set up a triple-display configuration, you must install motherboard drivers in the operating system first.
- After installing the HDMI/Mini-DisplayPort device, make sure to set the default sound playback device to HDMI/DisplayPort. (The item name may differ depending on your operating system.)

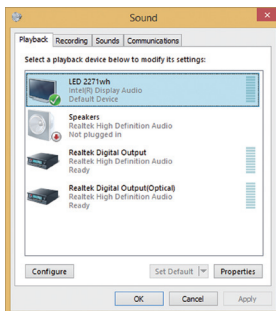

In Windows 8.1, select Apps>Control Panel>Hardware and Sound>Sound>Playback, set Intel(R) Display Audio to the default playback device.

(Note) The DVI-D port does not support D-Sub connection by adapter.

④ USB Type-C™ Port

The reversible USB port supports the USB 3.1 specification and is compatible to the USB 3.0/2.0 specification. Use this port for USB devices.

④ RJ-45 LAN Port

The Gigabit Ethernet LAN port provides Internet connection at up to 1 Gbps data rate. The following describes the states of the LAN port LEDs.

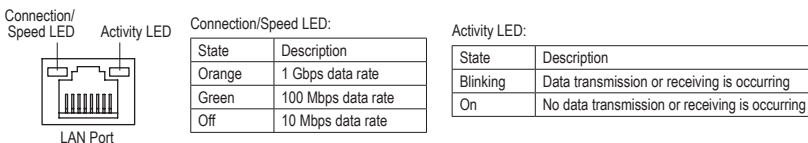

④ USB 3.0/2.0 Port (White)

The USB 3.0 port supports the USB 3.0 specification and is compatible to the USB 2.0/1.1 specification. Use this port for USB devices. Before using Q-Flash Plus, make sure to insert the USB flash drive ^(Note) into this port first.

④ USB 3.1 Port

The USB 3.1 port supports the USB 3.1 specification and is compatible to the USB 3.0/ 2.0/1.1 specification. Use this port for USB devices.

④ Center/Subwoofer Speaker Out (Orange)

Use this audio jack to connect center/subwoofer speakers in a 5.1/7.1-channel audio configuration.

④ Rear Speaker Out (Black)

This jack can be used to connect front speakers in a 4/5.1/7.1-channel audio configuration.

④ Optical S/PDIF Out Connector

This connector provides digital audio out to an external audio system that supports digital optical audio. Before using this feature, ensure that your audio system provides an optical digital audio in connector.

④ Line In (Blue)

The line in jack. Use this audio jack for line in devices such as an optical drive, walkman, etc.

④ Line Out (Green)

The line out jack. This jack supports audio amplifying function. For better sound quality, it is recommended that you connect your headphone/speaker to this jack (actual effects may vary by the device being used). Use this audio jack for a headphone or 2-channel speaker. This jack can be used to connect front speakers in a 4/5.1/7.1-channel audio configuration.

④ Mic In (Pink)

The Mic in jack.



If you want to install a Side Speaker, you need to retask either the Line in or Mic in jack to be Side Speaker out through the audio driver. Refer to the instructions on setting up a 2/4/5.1/7.1-channel audio configuration in Chapter 6, "Configuring 2/4/5.1/7.1-Channel Audio."



- When removing the cable connected to a back panel connector, first remove the cable from your device and then remove it from the motherboard.
- When removing the cable, pull it straight out from the connector. Do not rock it side to side to prevent an electrical short inside the cable connector.

(Note) The USB flash drive must be a USB 2.0 flash drive.

1-8 Onboard Buttons, Switches, and LEDs

BIOS Switches and BIOS LED Indicators

The BIOS switch (BIOS_SW) allows users to easily select a different BIOS for boot up or overclocking, helping to reduce BIOS failure during overclocking. The DualBIOS switch (SB) allows enabling or disabling of the Dual BIOS function. The LED indicator (M BIOS_LED/B BIOS_LED) shows which BIOS is active.

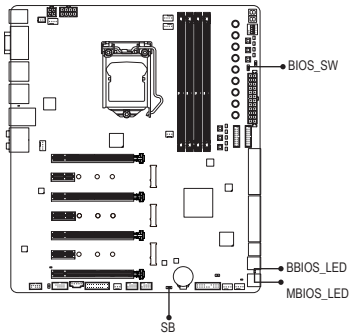

BIOS Switch (BIOS_SW):

2 1
1: Main BIOS (Boot from the main BIOS)

2 1
1: Backup BIOS (Boot from the backup BIOS)

DualBIOS Switch (SB):

2 1
1: Dual BIOS

2 1
2: Single BIOS

BIOS LED Indicators:

MBIOS_LED (The main BIOS is active)

BBIOS_LED (The backup BIOS is active)

Quick Buttons

This motherboard has four quick buttons: Power, Reset, Clear CMOS, and Clear Battery. The power button and reset button allow users to quickly turn on/off or reset the computer in an open-case environment when they want to change hardware components or conduct hardware testing. Use this button to clear the BIOS configuration and reset the CMOS values to factory defaults when needed. The Clear Battery button has the same function as removing the battery from the motherboard.

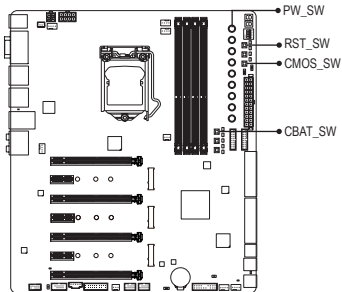

PW_SW: Power Button

RST_SW: Reset Button

CMOS_SW: Clear CMOS Button

CBAT_SW : Clear Battery Button



- Always turn off your computer and unplug the power cord from the power outlet before using the clear CMOS button.
- Always turn off the power of the power supply before using the clear battery button. After pressing this button, make sure to wait for five minutes before you turn on the computer.
- Do not use the clear CMOS or clear battery button when the system is on, or the system may shutdown and data loss or damage may occur.
- After system restart, go to BIOS Setup to load factory defaults (select Load Optimized Defaults) or manually configure the BIOS settings (refer to Chapter 2, "BIOS Setup," for BIOS configurations).

OC PCIe Switch (PCIE_SW)

The OC PCIe switch allows you to manually turn off specific PCI Express slot(s) (except for the PCI Express x1 slot) without physical removal.

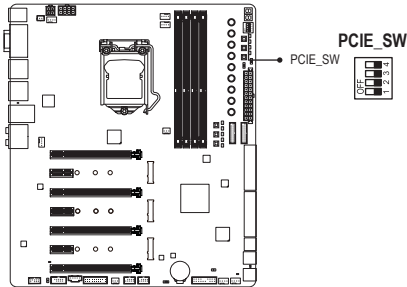

Slot	DIP Setting			
	DIP 1	DIP 2	DIP 3	DIP 4
Disabling PCIeX16_1	OFF	ON	ON	ON
Disabling PCIeX8_1	ON	OFF	ON	ON
Disabling PCIeX16_2	ON	ON	OFF	ON
Disabling PCIeX8_2	ON	ON	ON	OFF

OC Buttons

GIGABYTE's unique OC buttons help enthusiasts and overclockers not only get the most performance from their hardware, but also the absolute most enjoyable OC experience with features like overclocking the CPU in real-time, automatically loading the most optimized overclocking configuration for the processor and memory, and loading users' customized settings, etc.

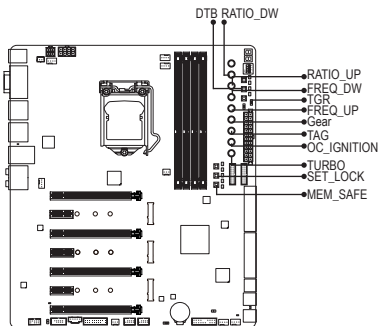

CPU Ratio Down Button (RATIO_DW):

Lowers the CPU ratio.

CPU Ratio Up Button (RATIO_UP):

Raises the CPU ratio.

CPU BCLK Down Button (FREQ_DW):

Lowers the CPU base clock.

CPU BCLK Up Button (FREQ_UP):

Raises the CPU base clock.

Gear Button

Changes BCLK stepping to 0.1 MHz or 1 MHz.

OC Tag Button (TAG):

This button allows users to load their customized settings (using the Save to Tag profile created in BIOS Setup) so you can apply your custom settings after clearing CMOS.

OC Ignition Button (OC_IGNITION):

The OC Ignition feature maintains power to your motherboard and connected components while the system is shut down. After pressing this button, be sure to press the power button to take effect. Please note that the system will not be able to enter S3 mode if this feature is enabled.

OC Turbo Button (TURBO):

Press this button to load the most optimized GIGABYTE overclocking configuration for your processor and memory.

Direct to BIOS Button (DTB):

This button helps users more easily to directly enter the BIOS at any time before rebooting the system. (Pressing this button during the POST process allows you to immediately enter BIOS Setup. Enter BIOS Setup directly on next boot if the button is pressed after the POST process.)

Memory Safe Button (MEM_SAFE):

Pressing the Memory Safe button engages a fail- safe mode that allows the system to boot in a safe memory configuration, regardless of the DIMM speed or CAS rating. The system will reboot after completion. (Note: Engaging Memory Safe may impact system memory performance.)

Settings Lock Button (SET_LOCK):

The GIGABYTE settings lock button allows the system to automatically remember your last successful settings, even after clearing CMOS. With one touch, the Settings Lock button can quickly revert to the previous good settings; a very useful tool for overclockers tuning their BIOS to perfection.

OC Trigger switch (TGR):

This switch allows the overclockers to jump between low and extremely high frequencies in an instant. After remaining at a low frequency during system boot and OS optimization, the overclocker can then engage the Trigger Switch to instantly hit the target frequency, save their score submission, grab a screen shot, and watch the records tumble.

 1: Target frequency set in BIOS Setup or other overclocking application.

 2: Safe frequency (using the lowest CPU ratio, which may vary by CPU)







Before using the overclocking buttons, make sure to load the optimized defaults in BIOS Setup to return the BIOS settings to factory defaults.

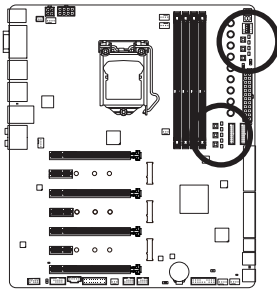



Onboard Voltage Measurement Module

Use a multimeter to measure the following motherboard voltages. You can employ one of the following two ways to measure component voltages.



- Pin 1  VCORE
- Pin 1  VDIMM
- Pin 1  VSA
- Pin 1  VCCIO

Pin No.	Definition
1	Power
2	GND

- Pin 1  DDRVTT
- Pin 1  VCCPLL
- Pin 1  VAXG
- Pin 1  PCHIO
- Pin 1  VPP_25V

Method I (Using the included voltage measurement cable):

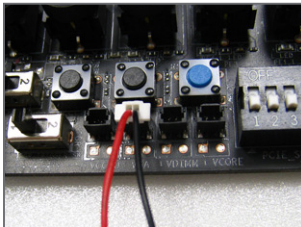

Steps:

Connect the included voltage measurement cable to a voltage measurement header and your multimeter as shown. Please note the red wire is the positive and must be connected to the pin 1 (Power).

Method II (Connecting the multimeter directly):

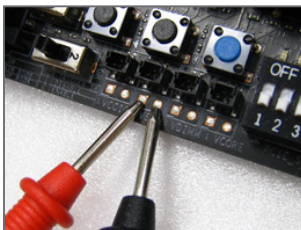

Steps:

Connect the red lead of the multimeter to the pin 1 (Power) of a voltage measurement point and the black lead to the pin 2 (ground).

1-9 Internal Connectors

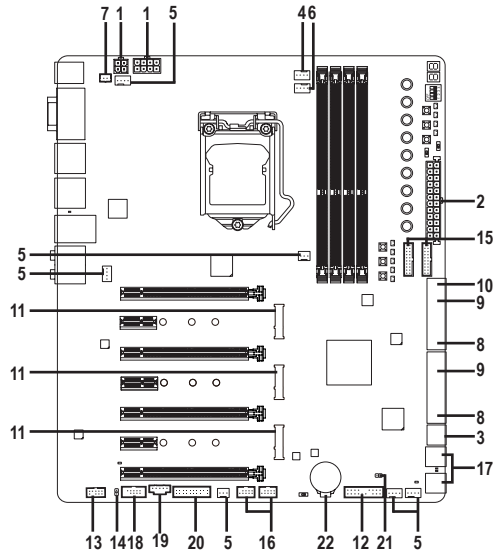

1) ATX_12V_2X4/ATX_12V	12) F_PANEL
2) ATX	13) F_AUDIO
3) OC_PEG	14) SPDIF_O
4) CPU_FAN	15) F_USB30_1/F_USB30_2
5) SYS_FAN1/2/3/4/5/6	16) F_USB1/F_USB2
6) CPU_OPT	17) F_USB3/F_USB4
7) LED_CON1	18) COMA
8) SATA EXPRESS	19) THB_C
9) SATA3 0/1/2/3/4/5	20) TPM
10) SATA3 6/7	21) CLR_CMOS
11) M2C_32G/M2D_32G/M2A_32G	22) BAT



Read the following guidelines before connecting external devices:

- First make sure your devices are compliant with the connectors you wish to connect.
- Before installing the devices, be sure to turn off the devices and your computer. Unplug the power cord from the power outlet to prevent damage to the devices.
- After installing the device and before turning on the computer, make sure the device cable has been securely attached to the connector on the motherboard.

1/2) ATX_12V/ATX_12V_2X4/ATX (2x2, 2x4 12V Power Connectors and 2x12 Main Power Connector)

With the use of the power connector, the power supply can supply enough stable power to all the components on the motherboard. Before connecting the power connector, first make sure the power supply is turned off and all devices are properly installed. The power connector possesses a foolproof design. Connect the power supply cable to the power connector in the correct orientation.

The 12V power connector mainly supplies power to the CPU. If the 12V power connector is not connected, the computer will not start.



To meet expansion requirements, it is recommended that a power supply that can withstand high power consumption be used (500W or greater). If a power supply is used that does not provide the required power, the result can lead to an unstable or unbootable system.

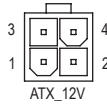
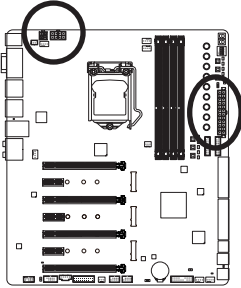

ATX_12V

ATX_12V:

Pin No.	Definition
1	GND
2	GND
3	+12V
4	+12V

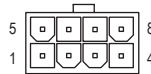

ATX_12V_2X4

ATX_12V_2X4:

Pin No.	Definition
1	GND (Only for 2x4-pin 12V)
2	GND (Only for 2x4-pin 12V)
3	GND
4	GND
5	+12V (Only for 2x4-pin 12V)
6	+12V (Only for 2x4-pin 12V)
7	+12V
8	+12V

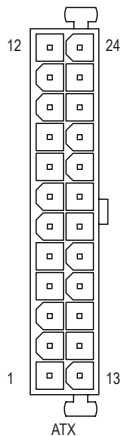

ATX:

Pin No.	Definition	Pin No.	Definition
1	3.3V	13	3.3V
2	3.3V	14	-12V
3	GND	15	GND
4	+5V	16	PS_ON (soft On/Off)
5	GND	17	GND
6	+5V	18	GND
7	GND	19	GND
8	Power Good	20	-5V
9	5VSB (stand by +5V)	21	+5V
10	+12V	22	+5V
11	+12V (Only for 2x12-pin ATX)	23	+5V (Only for 2x12-pin ATX)
12	3.3V (Only for 2x12-pin ATX)	24	GND (Only for 2x12-pin ATX)

3) OC_PEG (PCIe Power Connector)

The power connector provides auxiliary power to the onboard PCI Express x16 slots. When two or more graphics cards are installed, we recommend that you connect the 2x3 power cable from the power supply to this connector to ensure system stability.

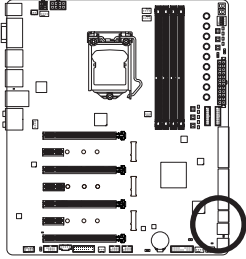

Pin No.	Definition
1	+12V
2	+12V
3	+12V
4	GND
5	GND
6	GND

4/5) CPU_FAN/SYS_FAN1/2/3/4/5/6 (Fan Headers)

The motherboard has a 4-pin CPU fan header (CPU_FAN), four 4-pin (SYS_FAN1/SYS_FAN2/SYS_FAN3/SYS_FAN4) and two 3-pin (SYS_FAN5/SYS_FAN6) system fan headers. Most fan headers possess a foolproof insertion design. When connecting a fan cable, be sure to connect it in the correct orientation (the black connector wire is the ground wire). The speed control function requires the use of a fan with fan speed control design. For optimum heat dissipation, it is recommended that a system fan be installed inside the chassis.

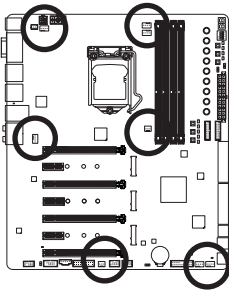

CPU_FAN:

Pin No.	Definition
1	GND
2	+12V
3	Sense
4	Speed Control

SYS_FAN1/2/3/4:

Pin No.	Definition
1	GND
2	Speed Control
3	Sense
4	VCC

SYS_FAN5/6:

Pin No.	Definition
1	GND
2	+12V
3	NC



- Be sure to connect fan cables to the fan headers to prevent your CPU and system from overheating. Overheating may result in damage to the CPU or the system may hang.
- These fan headers are not configuration jumper blocks. Do not place a jumper cap on the headers.

6) CPU_OPT (Water Cooling CPU Fan Header)

The fan header is 4-pin and possesses a foolproof insertion design. When connecting a fan cable, be sure to connect it in the correct orientation (the black connector wire is the ground wire). The speed control function requires the use of a fan with fan speed control design.

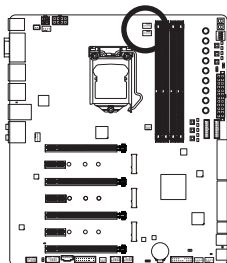

Pin No.	Definition
1	GND
2	Speed Control
3	Sense
4	VCC

7) LED_CON1 (I/O Shield Audio LED Power Connector)

The power connector provides power to the LEDs on the I/O shield on the motherboard back panel.

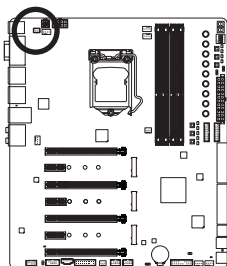

Pin No.	Definition
1	+5V
2	LED Control

8) SATA EXPRESS (SATA Express Connectors)

Each SATA Express connector supports a single SATA Express device.

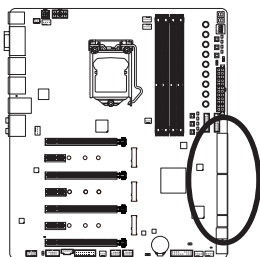

9) SATA3 0/1/2/3/4/5 (SATA 6Gb/s Connectors, Controlled by Intel® Z170 Chipset)

The SATA connectors conform to SATA 6Gb/s standard and are compatible with SATA 3Gb/s and SATA 1.5Gb/s standard. Each SATA connector supports a single SATA device. The Intel® Chipset supports RAID 0, RAID 1, RAID 5, and RAID 10. Refer to Chapter 3, "Configuring a RAID Set," for instructions on configuring a RAID array.

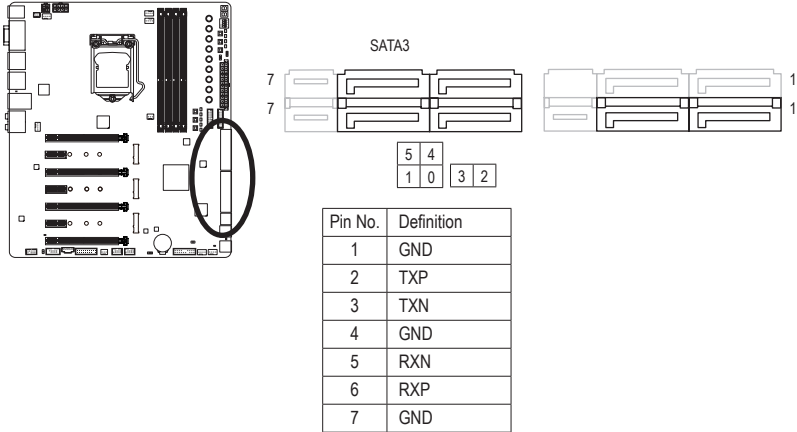

To enable hot-plugging for the SATA ports, refer to Chapter 2, "BIOS Setup," "Peripherals\SATA Configuration," for more information.

10) SATA3 6/7 (SATA 6Gb/s Connectors, Controlled by ASMedia® ASM1061 Chip)

The SATA connectors conform to SATA 6Gb/s standard and are compatible with SATA 3Gb/s and SATA 1.5Gb/s standard. Each SATA connector supports a single SATA device.

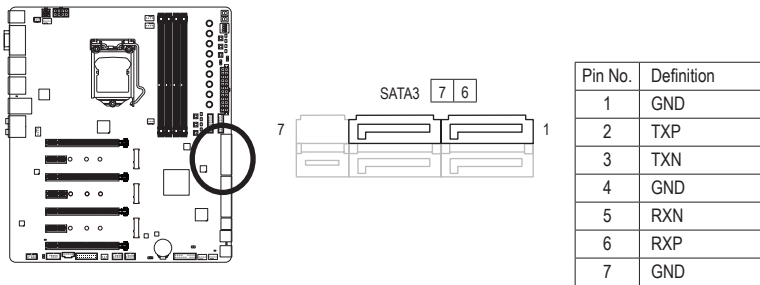

11) M2C_32G/M2D_32G/M2A_32G (M.2 Socket 3 Connectors)

The M.2 connectors support M.2 SATA SSDs and M.2 PCIe SSDs and support RAID configuration through the Intel® Chipset. Please note that an M.2 PCIe SSD cannot be used to create a RAID set either with an M.2 SATA SSD or a SATA hard drive. To create a RAID array with an M.2 PCIe SSD, you must set up the configuration in UEFI BIOS mode. Refer to Chapter 3, "Configuring a RAID Set," for instructions on configuring a RAID array.

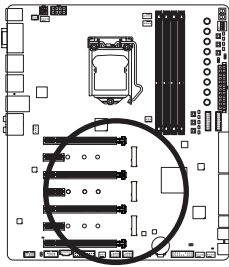

○ 80C ○ 60C ○ 42C

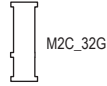

○ 80D ○ 60D ○ 42D

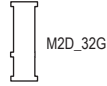

○ 80A ○ 60A ○ 42A

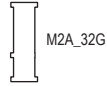

Follow the steps below to correctly install an M.2 SSD in the M.2 connector.

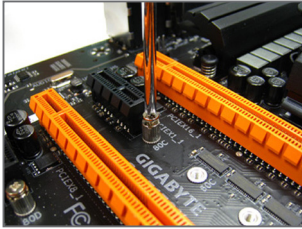

Step 1:
Use a screw driver to unfasten the screw and nut from the motherboard. Locate the proper mounting hole for the M.2 SSD to be installed and then screw the nut first.

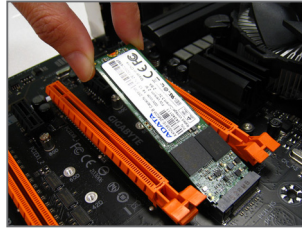

Step 2:
Slide the M.2 SSD into the connector at an angle.

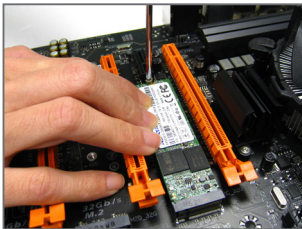

Step 3:
Press the M.2 SSD down and then secure it with the screw.



Step 4:
The installation is completed, as shown in the picture above.



On the motherboard there are three length adjustment holes for the M.2 SSD. Select the proper hole for the M.2 SSD to be installed and refasten the screw and nut.

►► When installing different types of M.2 SSDs (including SATA SSDs, PCIe x4 SSDs, and PCIe x2 SSDs), be sure to refer to the supported configurations in the tables below according to the operating mode of your SATA controller (AHCI mode or RAID mode).

• **AHCI mode:**

M2C_32G M.2 connector

Connector	SATA3_0	SATA3_1	SATA3_2	SATA3_3	SATA3_4	SATA3_5
Type of SSD	SATA Express		SATA Express		SATA Express	
SATA SSD	✓	✓	✓	✓	✗	✓
PCIe x4 SSD	✓	✓	✓	✓	✗	✗
	✓ (Note)		✓		✓ (Note)	
PCIe x2 SSD	✓	✓	✓	✓	✓	✓
No SSDs	✓	✓	✓	✓	✓	✓
Installed	✓	✓	✓	✓	✓	✓

✓ : Supported, ✗: Not supported.

M2D_32G M.2 connector

Connector	SATA3_0	SATA3_1	SATA3_2	SATA3_3	SATA3_4	SATA3_5
Type of SSD	SATA Express		SATA Express		SATA Express	
SATA SSD	✓	✓	✓	✗	✓	✓
PCIe x4 SSD	✗	✗	✗	✗	✓	✓
	✓ (Note)		✗		✓	
PCIe x2 SSD	✓	✓	✗	✗	✓	✓
No SSDs	✓	✓	✓	✓	✓	✓
Installed	✓	✓	✓	✓	✓	✓

✓ : Supported, ✗: Not supported.

M2A_32G M.2 connector

Connector	SATA3_0	SATA3_1	SATA3_2	SATA3_3	SATA3_4	SATA3_5
Type of SSD	SATA Express		SATA Express		SATA Express	
SATA SSD	✗	✓	✓	✓	✓	✓
PCIe x4 SSD	✓	✓	✓	✓	✓	✓
	✓		✓		✓	
PCIe x2 SSD	✓	✓	✓	✓	✓	✓
No SSDs	✓	✓	✓	✓	✓	✓
Installed	✓	✓	✓	✓	✓	✓

✓ : Supported, ✗: Not supported.

(Note) The PCIe x4 SSD runs at x2 speed.

• RAID mode:

M2C_32G M.2 connector

Connector	SATA3_0	SATA3_1	SATA3_2	SATA3_3	SATA3_4	SATA3_5
Type of SSD	SATA Express		SATA Express		SATA Express	
SATA SSD	✓	✓	✓	✓	✗	✓
	✓			✓	✗	
PCIe x4 SSD	✓	✓	✓	✓	✗	✗
	✓			✓	✓ ^(Note)	
PCIe x2 SSD	✓	✓	✓	✓	✓	✗
	✓			✓	✗	
No SSDs	✓	✓	✓	✓	✓	✓
Installed		✓		✓		✓

✓ : Supported, ✗ : Not supported.

M2D_32G M.2 connector

Connector	SATA3_0	SATA3_1	SATA3_2	SATA3_3	SATA3_4	SATA3_5
Type of SSD	SATA Express		SATA Express		SATA Express	
SATA SSD	✓	✓	✓	✗	✓	✓
	✓			✗	✓	
PCIe x4 SSD	✗	✗	✗	✗	✓	✓
	✓ ^(Note)			✗	✓	
PCIe x2 SSD	✓	✓	✗	✗	✓	✓
	✓			✗	✓	
No SSDs	✓	✓	✓	✓	✓	✓
Installed		✓		✓		✓

✓ : Supported, ✗ : Not supported.

M2A_32G M.2 connector

Connector	SATA3_0	SATA3_1	SATA3_2	SATA3_3	SATA3_4	SATA3_5
Type of SSD	SATA Express		SATA Express		SATA Express	
SATA SSD	✗	✓	✓	✓	✓	✓
	✓			✓	✓	
PCIe x4 SSD	✓	✓	✓	✓	✓	✓
	✓			✓	✓	
PCIe x2 SSD	✓	✓	✓	✓	✓	✓
	✓			✓	✓	
No SSDs	✓	✓	✓	✓	✓	✓
Installed		✓		✓		✓

✓ : Supported, ✗ : Not supported.

(Note) The PCIe x4 SSD runs at x2 speed.

12) F_PANEL (Front Panel Header)

Connect the power switch, reset switch, speaker, chassis intrusion switch/sensor and system status indicator on the chassis to this header according to the pin assignments below. Note the positive and negative pins before connecting the cables.

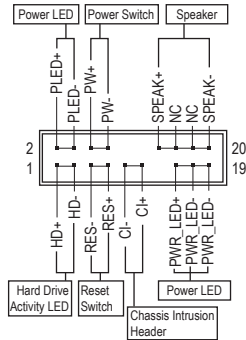
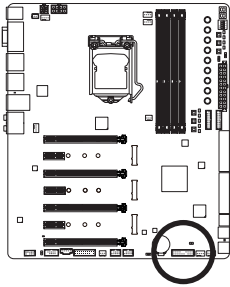

- **PLED/PWR_LED** (Power LED, Yellow/Purple):

System Status	LED
S0	On
S3/S4/S5	Off

Connects to the power status indicator on the chassis front panel. The LED is on when the system is operating. The LED is off when the system is in S3/S4 sleep state or powered off (S5).

- **PW** (Power Switch, Red):

Connects to the power switch on the chassis front panel. You may configure the way to turn off your system using the power switch (refer to Chapter 2, "BIOS Setup," "Power Management," for more information).

- **SPEAK** (Speaker, Orange):

Connects to the speaker on the chassis front panel. The system reports system startup status by issuing a beep code. One single short beep will be heard if no problem is detected at system startup.

- **HD** (Hard Drive Activity LED, Blue):

Connects to the hard drive activity LED on the chassis front panel. The LED is on when the hard drive is reading or writing data.

- **RES** (Reset Switch, Green):

Connects to the reset switch on the chassis front panel. Press the reset switch to restart the computer if the computer freezes and fails to perform a normal restart.

- **CI** (Chassis Intrusion Header, Gray):

Connects to the chassis intrusion switch/sensor on the chassis that can detect if the chassis cover has been removed. This function requires a chassis with a chassis intrusion switch/sensor.

- **NC** (Orange): No Connection.



The front panel design may differ by chassis. A front panel module mainly consists of power switch, reset switch, power LED, hard drive activity LED, speaker and etc. When connecting your chassis front panel module to this header, make sure the wire assignments and the pin assignments are matched correctly.

13) F_AUDIO (Front Panel Audio Header)

The front panel audio header supports Intel High Definition audio (HD) and AC'97 audio. You may connect your chassis front panel audio module to this header. Make sure the wire assignments of the module connector match the pin assignments of the motherboard header. Incorrect connection between the module connector and the motherboard header will make the device unable to work or even damage it.

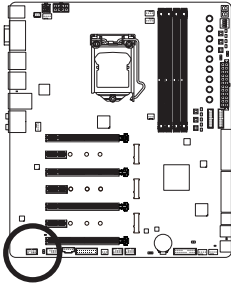

For HD Front Panel Audio:

Pin No.	Definition
1	MIC2_L
2	GND
3	MIC2_R
4	-ACZ_DET
5	LINE2_R
6	Sense
7	FAUDIO_JD
8	No Pin
9	LINE2_L
10	Sense

For AC'97 Front Panel Audio:

Pin No.	Definition
1	MIC
2	GND
3	MIC Power
4	NC
5	Line Out (R)
6	NC
7	NC
8	No Pin
9	Line Out (L)
10	NC



- The front panel audio header supports HD audio by default. If your chassis provides an AC'97 front panel audio module, refer to the instructions on how to activate AC'97 functionality via the audio software in Chapter 6, "Configuring 2/4/5.1/7.1-Channel Audio."
- Audio signals will be present on both of the front and back panel audio connections simultaneously. If you want to mute the back panel audio (only supported when using an HD front panel audio module), refer to Chapter 6, "Configuring 2/4/5.1/7.1-Channel Audio."
- Some chassis provide a front panel audio module that has separated connectors on each wire instead of a single plug. For information about connecting the front panel audio module that has different wire assignments, please contact the chassis manufacturer.

14) SPDIF_O (S/PDIF Out Header)

This header supports digital S/PDIF Out and connects a S/PDIF digital audio cable (provided by expansion cards) for digital audio output from your motherboard to certain expansion cards like graphics cards and sound cards. For example, some graphics cards may require you to use a S/PDIF digital audio cable for digital audio output from your motherboard to your graphics card if you wish to connect an HDMI display to the graphics card and have digital audio output from the HDMI display at the same time.

For information about connecting the S/PDIF digital audio cable, carefully read the manual for your expansion card.

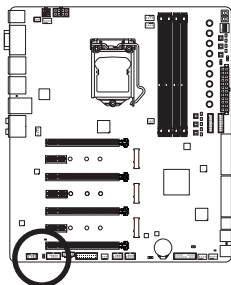

Pin No.	Definition
1	SPDIFO
2	GND

15) F_USB30_1/F_USB30_2 (USB 3.0/2.0 Headers)

The headers conform to USB 3.0/2.0 specification and can provide two USB ports. For purchasing the optional 3.5" front panel that provides two USB 3.0/2.0 ports, please contact the local dealer.

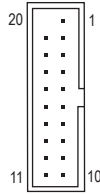
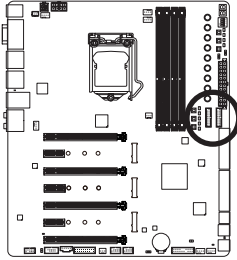

Pin No.	Definition	Pin No.	Definition
1	VBUS	11	D2+
2	SSRX1-	12	D2-
3	SSRX1+	13	GND
4	GND	14	SSTX2+
5	SSTX1-	15	SSTX2-
6	SSTX1+	16	GND
7	GND	17	SSRX2+
8	D1-	18	SSRX2-
9	D1+	19	VBUS
10	NC	20	No Pin



Prior to installing the USB front panel, be sure to turn off your computer and unplug the power cord from the power outlet to prevent damage to the USB front panel.

16) F_USB1/F_USB2 (USB 2.0/1.1 Headers)

The headers conform to USB 2.0/1.1 specification. Each USB header can provide two USB ports via an optional USB bracket. For purchasing the optional USB bracket, please contact the local dealer.

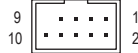
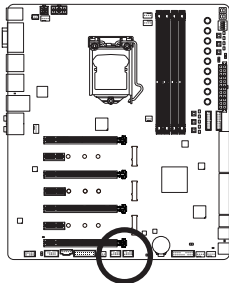

Pin No.	Definition
1	Power (5V)
2	Power (5V)
3	USB DX-
4	USB DY-
5	USB DX+
6	USB DY+
7	GND
8	GND
9	No Pin
10	NC



- Do not plug the IEEE 1394 bracket (2x5-pin) cable into the USB 2.0/1.1 header.
- Prior to installing the USB bracket, be sure to turn off your computer and unplug the power cord from the power outlet to prevent damage to the USB bracket.

17) F_USB3/F_USB4 (USB 2.0/1.1 Ports)

The two USB ports make it easier to save data, flash the BIOS or install software in open bench testing platforms whether for extreme overclocking or simply pretesting the PC before final component installation inside a case scenarios where accessing the rear panel I/O can be an inconvenience.

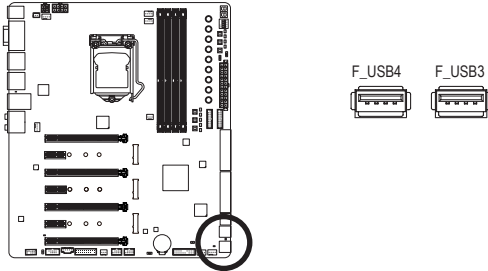

18) COMA (Serial Port Header)

The COM header can provide one serial port via an optional COM port cable. For purchasing the optional COM port cable, please contact the local dealer.

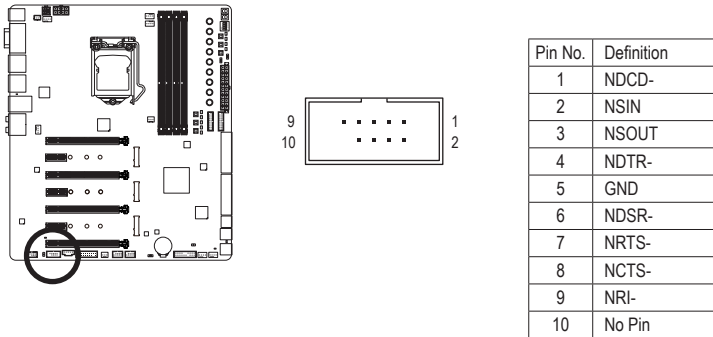

19) THB_C (Thunderbolt™ Add-in Card Connector)

This connector is for a GIGABYTE Thunderbolt™ add-in card.

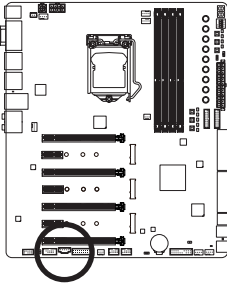

Pin No.	Definition
1	GPIOA
2	GPIOB
3	N_SLP_S3
4	N_S4_S5
5	GND



Supports a Thunderbolt™ add-in card.

20) TPM (Trusted Platform Module Header)

You may connect a TPM (Trusted Platform Module) to this header.

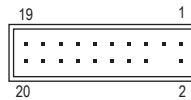
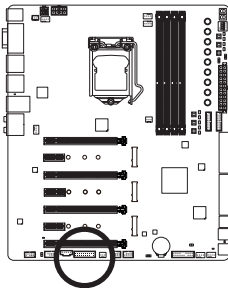

Pin No.	Definition	Pin No.	Definition
1	LCLK	11	LAD0
2	GND	12	GND
3	LFRAME	13	NC
4	No Pin	14	NC
5	LRESET	15	SB3V
6	NC	16	SERIRQ
7	LAD3	17	GND
8	LAD2	18	NC
9	VCC3	19	NC
10	LAD1	20	SUSCLK

21) CLR_CMOS (Clear CMOS Jumper)

Use this jumper to clear the BIOS configuration and reset the CMOS values to factory defaults. To clear the CMOS values, use a metal object like a screwdriver to touch the two pins for a few seconds.

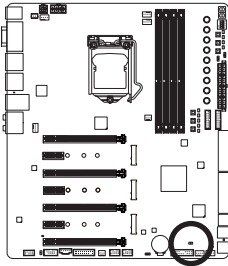

 Open: Normal

 Short: Clear CMOS Values



- Always turn off your computer and unplug the power cord from the power outlet before clearing the CMOS values.
- After system restart, go to BIOS Setup to load factory defaults (select Load Optimized Defaults) or manually configure the BIOS settings (refer to Chapter 2, "BIOS Setup," for BIOS configurations).

22) BAT (Battery)

The battery provides power to keep the values (such as BIOS configurations, date, and time information) in the CMOS when the computer is turned off. Replace the battery when the battery voltage drops to a low level, or the CMOS values may not be accurate or may be lost.

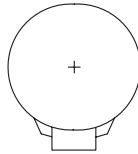
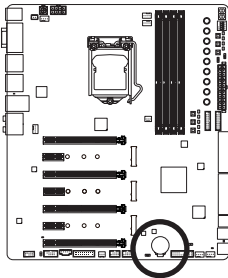

You may clear the CMOS values by removing the battery:

1. Turn off your computer and unplug the power cord.
2. Gently remove the battery from the battery holder and wait for one minute. (Or use a metal object like a screwdriver to touch the positive and negative terminals of the battery holder, making them short for 5 seconds.)
3. Replace the battery.
4. Plug in the power cord and restart your computer.



- Always turn off your computer and unplug the power cord before replacing the battery.
- Replace the battery with an equivalent one. Danger of explosion if the battery is replaced with an incorrect model.
- Contact the place of purchase or local dealer if you are not able to replace the battery by yourself or uncertain about the battery model.
- When installing the battery, note the orientation of the positive side (+) and the negative side (-) of the battery (the positive side should face up).
- Used batteries must be handled in accordance with local environmental regulations.

Chapter 2 BIOS Setup

BIOS (Basic Input and Output System) records hardware parameters of the system in the CMOS on the motherboard. Its major functions include conducting the Power-On Self-Test (POST) during system startup, saving system parameters and loading operating system, etc. BIOS includes a BIOS Setup program that allows the user to modify basic system configuration settings or to activate certain system features.

When the power is turned off, the battery on the motherboard supplies the necessary power to the CMOS to keep the configuration values in the CMOS.

To access the BIOS Setup program, press the <Delete> key during the POST when the power is turned on.

To upgrade the BIOS, use either the GIGABYTE Q-Flash or @BIOS utility.

- Q-Flash allows the user to quickly and easily upgrade or back up BIOS without entering the operating system.
- @BIOS is a Windows-based utility that searches and downloads the latest version of BIOS from the Internet and updates the BIOS.

For instructions on using the Q-Flash and @BIOS utilities, refer to Chapter 5, "BIOS Update Utilities."



- Because BIOS flashing is potentially risky, if you do not encounter problems using the current version of BIOS, it is recommended that you not flash the BIOS. To flash the BIOS, do it with caution. Inadequate BIOS flashing may result in system malfunction.
- It is recommended that you not alter the default settings (unless you need to) to prevent system instability or other unexpected results. Inadequately altering the settings may result in system's failure to boot. If this occurs, try to clear the CMOS values and reset the board to default values. (Refer to the "Load Optimized Defaults" section in this chapter or introductions of the battery or the clear CMOS jumper/button in Chapter 1 for how to clear the CMOS values.)

2-1 Startup Screen

The following startup Logo screen will appear when the computer boots.



Function Keys:

: BIOS SETUP \ Q-FLASH

Press the <Delete> key to enter BIOS Setup or to access the Q-Flash utility in BIOS Setup.

<F9>: SYSTEM INFORMATION

Press the <F9> key to display your system information.

<F12>: BOOT MENU

Boot Menu allows you to set the first boot device without entering BIOS Setup. In Boot Menu, use the up arrow key <↑> or the down arrow key <↓> to select the first boot device, then press <Enter> to accept. The system will boot from the device immediately.

Note: The setting in Boot Menu is effective for one time only. After system restart, the device boot order will still be based on BIOS Setup settings.

<END>: Q-FLASH

Press the <End> key to access the Q-Flash utility directly without having to enter BIOS Setup first.

2-2 The Main Menu

A. Startup Guide (Default)

The Startup Guide screen simplifies conventional complicated BIOS setup menus and presents only the most frequently used options in the easy-to-use interface. It helps first-time users to perform basic system setups more quickly and easily.

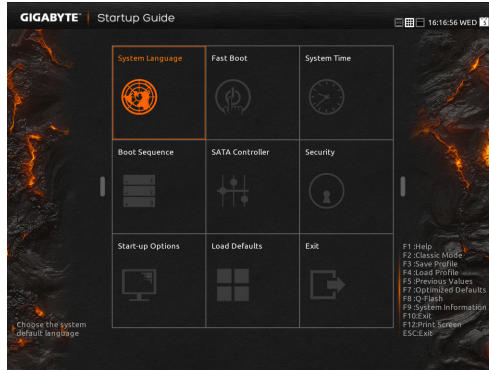

B. ST Mode (Smart Tweak Mode)

Differing from traditional UEFI interface, the ST Mode provides a fancy and user-friendly BIOS environment where users can easily point and click through various settings and make adjustments for optimum performance. In ST Mode, you can use your mouse to move through the option menus for quick configuration or press <F2> to switch to the traditional BIOS Setup screen.



- When the system is not stable as usual, select the **Load Optimized Defaults** item to set your system to its defaults.
- The BIOS Setup menus described in this chapter are for reference only and may differ by BIOS version.

C. Classic Mode

Classic Mode is the conventional BIOS Setup interface where you can press the arrow keys on your keyboard to move among the items and press <Enter> to accept or enter a sub-menu. Or you can use your mouse to select the item you want.

(Sample BIOS Version: F11)

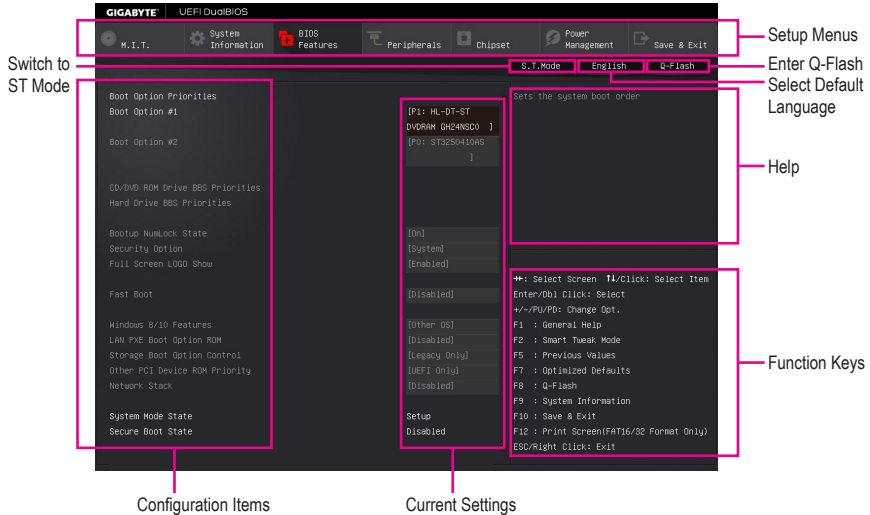

Classic Setup Function Keys

<←><→>	Move the selection bar to select a setup menu
<↑><↓>	Move the selection bar to select an configuration item on a menu
<Enter>	Execute command or enter a menu
<+></Page Up>	Increase the numeric value or make changes
<-></Page Down>	Decrease the numeric value or make changes
<F1>	Show descriptions of the function keys
<F2>	Switch to ST Mode or Startup Guide screen
<F5>	Restore the previous BIOS settings for the current submenus
<F7>	Load the Optimized BIOS default settings for the current submenus
<F8>	Access the Q-Flash utility
<F9>	Display system information
<F10>	Save all the changes and exit the BIOS Setup program
<F12>	Capture the current screen as an image and save it to your USB drive
<Esc>	Main Menu: Exit the BIOS Setup program Submenus: Exit current submenu

2-3 M.I.T.

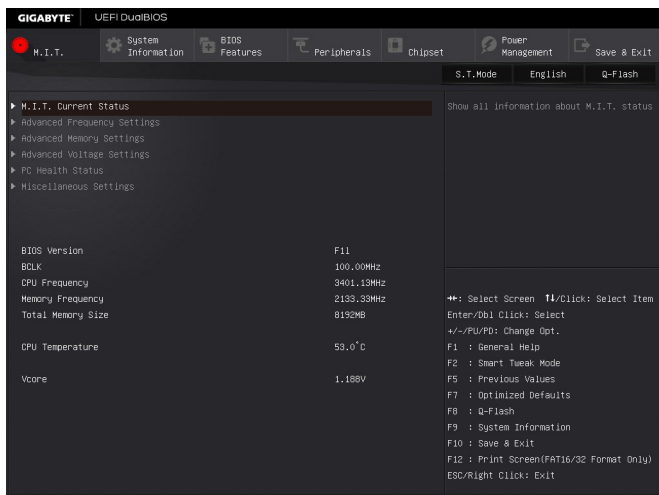

Whether the system will work stably with the overclock/overvoltage settings you made is dependent on your overall system configurations. Incorrectly doing overclock/overvoltage may result in damage to CPU, chipset, or memory and reduce the useful life of these components. This page is for advanced users only and we recommend you not to alter the default settings to prevent system instability or other unexpected results. (Inadequately altering the settings may result in system's failure to boot. If this occurs, clear the CMOS values and reset the board to default values.)

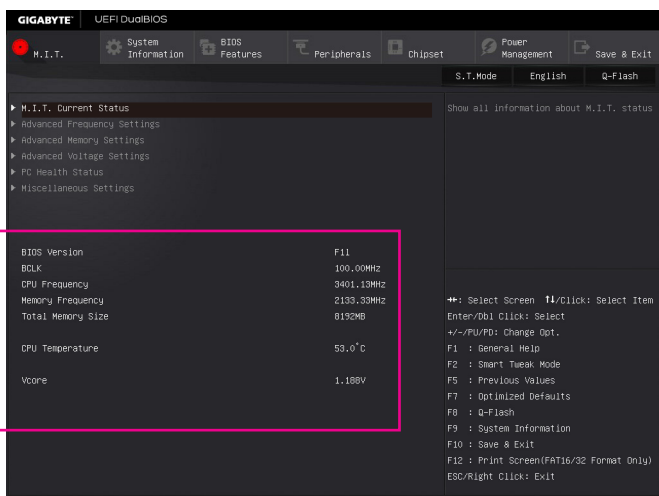

This section provides information on the BIOS version, CPU base clock, CPU frequency, memory frequency, total memory size, CPU temperature and CPU voltage, etc.

▶ M.I.T. Current Status

This screen provides information on CPU/memory frequencies/parameters.

▶ Advanced Frequency Settings

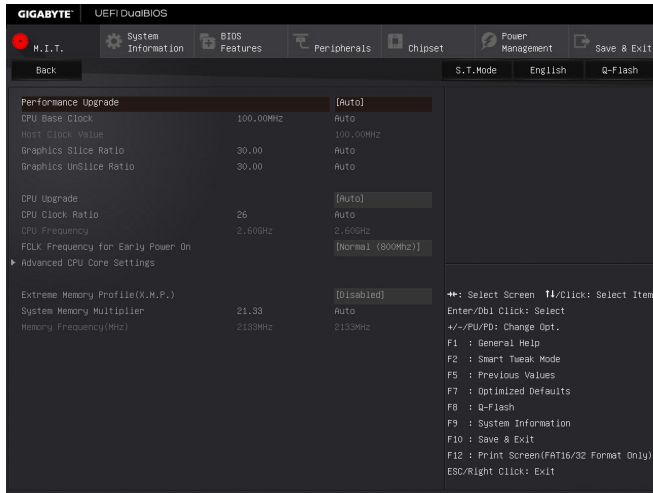

☞ Performance Upgrade^(Note)

Provides you with five different overclocking configurations. Options are: 20% Upgrade, 40% Upgrade, 60% Upgrade, 80% Upgrade, 100% Upgrade. (Default: Auto)

☞ CPU Base Clock

Allows you to manually set the CPU base clock in 0.01 MHz increments. (Default: Auto)

Important: It is highly recommended that the CPU frequency be set in accordance with the CPU specifications.

☞ Host Clock Value

This value changes with the **CPU Base Clock** setting.

☞ Graphics Slice Ratio

Allows you to set the Graphics Slice Ratio.

☞ Graphics UnSlice Ratio

Allows you to set the Graphics UnSlice Ratio.

☞ CPU Upgrade^(Note)

Allows you to set the CPU frequency. Options may vary depending on the CPU being used. (Default: Auto)

☞ CPU Clock Ratio

Allows you to alter the clock ratio for the installed CPU. The adjustable range is dependent on the CPU being installed.

☞ CPU Frequency

Displays the current operating CPU frequency.

(Note) This item is present only when you install a CPU that supports this feature. For more information about Intel® CPUs' unique features, please visit Intel's website.

⌄ FCLK Frequency for Early Power On

Allows you to set the FCLK frequency. Options are: Normal(800MHz), 1GHz, 400MHz. (Default: Normal(800MHz)).

▶ Advanced CPU Core Settings

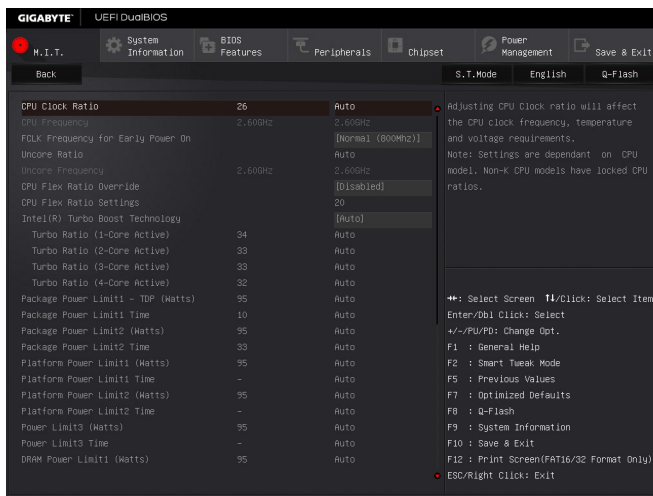

▶ Advanced CPU Core Settings

⌄ CPU Clock Ratio, CPU Frequency, FCLK Frequency for Early Power On

The settings above are synchronous to those under the same items on the **Advanced Frequency Settings** menu.

⌄ Uncore Ratio

Allows you to set the CPU Uncore ratio. The adjustable range is dependent on the CPU being used.

⌄ Uncore Frequency

Displays the current CPU Uncore frequency.

⌄ CPU Flex Ratio Override

Enables or disables the CPU Flex Ratio. The maximum CPU clock ratio will be based on the **CPU Flex Ratio Settings** value if **CPU Clock Ratio** is set to **Auto**. (Default: Disabled)

⌄ CPU Flex Ratio Settings

Allows you to set the CPU Flex Ratio. The adjustable range may vary by CPU. (Default: 20)

⌄ Intel(R) Turbo Boost Technology ^(Note)

Allows you to determine whether to enable the Intel® CPU Turbo Boost technology. **Auto** lets the BIOS automatically configure this setting. (Default: Auto)

⌄ Turbo Ratio ^(Note)

Allows you to set the CPU Turbo ratios for different number of active cores. **Auto** sets the CPU Turbo ratios according to the CPU specifications. (Default: Auto)

⌄ Power Limit TDP (Watts) / Power Limit Time

Allows you to set the power limit for CPU Turbo mode and how long it takes to operate at the specified power limit. If the specified value is exceeded, the CPU will automatically reduce the core frequency in order to reduce the power. **Auto** sets the power limit according to the CPU specifications. (Default: Auto)

(Note) This item is present only when you install a CPU that supports this feature. For more information about Intel® CPUs' unique features, please visit Intel's website.

- ☞ **Core Current Limit (Amps)**
 Allows you to set a current limit for CPU Turbo mode. When the CPU current exceeds the specified current limit, the CPU will automatically reduce the core frequency in order to reduce the current. **Auto** sets the power limit according to the CPU specifications. (Default: Auto)
- ☞ **No. of CPU Cores Enabled** ^(Note)
 Allows you to select the number of CPU cores to enable in an Intel® multi-core CPU (the number of CPU cores may vary by CPU). **Auto** lets the BIOS automatically configure this setting. (Default: Auto)
- ☞ **Hyper-Threading Technology** ^(Note)
 Allows you to determine whether to enable multi-threading technology when using an Intel® CPU that supports this function. This feature only works for operating systems that support multi-processor mode. **Auto** lets the BIOS automatically configure this setting. (Default: Auto)
- ☞ **CPU Enhanced Halt (C1E)** ^(Note)
 Enables or disables Intel® CPU Enhanced Halt (C1E) function, a CPU power-saving function in system halt state. When enabled, the CPU core frequency and voltage will be reduced during system halt state to decrease power consumption. **Auto** lets the BIOS automatically configure this setting. (Default: Auto)
- ☞ **C3 State Support** ^(Note)
 Allows you to determine whether to let the CPU enter C3 mode in system halt state. When enabled, the CPU core frequency and voltage will be reduced during system halt state to decrease power consumption. The C3 state is a more enhanced power-saving state than C1. **Auto** lets the BIOS automatically configure this setting. (Default: Auto)
- ☞ **C6/C7 State Support** ^(Note)
 Allows you to determine whether to let the CPU enter C6/C7 mode in system halt state. When enabled, the CPU core frequency and voltage will be reduced during system halt state to decrease power consumption. The C6/C7 state is a more enhanced power-saving state than C3. **Auto** lets the BIOS automatically configure this setting. (Default: Auto)
- ☞ **C8 State Support** ^(Note)
 Allows you to determine whether to let the CPU enter C8 mode in system halt state. When enabled, the CPU core frequency and voltage will be reduced during system halt state to decrease power consumption. The C8 state is a more enhanced power-saving state than C6/C7. **Auto** lets the BIOS automatically configure this setting. (Default: Auto)
- ☞ **Package C State Limit** ^(Note)
 Allows you to specify the C-state limit for the processor. **Auto** lets the BIOS automatically configure this setting. (Default: Auto)
- ☞ **CPU Thermal Monitor** ^(Note)
 Enables or disables Intel® Thermal Monitor function, a CPU overheating protection function. When enabled, the CPU core frequency and voltage will be reduced when the CPU is overheated. **Auto** lets the BIOS automatically configure this setting. (Default: Auto)
- ☞ **CPU EIST Function** ^(Note)
 Enables or disables Enhanced Intel® Speed Step Technology (EIST). Depending on CPU loading, Intel® EIST technology can dynamically and effectively lower the CPU voltage and core frequency to decrease average power consumption and heat production. **Auto** lets the BIOS automatically configure this setting. (Default: Auto)

(Note) This item is present only when you install a CPU that supports this feature. For more information about Intel® CPUs' unique features, please visit Intel's website.

⌄ Voltage Optimization

Allows you to determine whether to enable voltage optimization to reduce power consumption. (Default: Enabled)

⌄ RSR

Allows you to determine whether to automatically lower the CPU turbo ratio if the CPU voltage/temperature is too high. (Default: Enabled)

⌄ Hardware Prefetcher

Allows you to determine whether to enable hardware prefetcher to prefetch data and instructions from the memory into the cache. (Default: Enabled)

⌄ Adjacent Cache Line Prefetch

Allows you to determine whether to enable the adjacent cache line prefetch mechanism that lets the processor retrieve the requested cache line as well as the subsequent cache line. (Default: Enabled)

⌄ Extreme Memory Profile (X.M.P.) ^(Note)

Allows the BIOS to read the SPD data on XMP memory module(s) to enhance memory performance when enabled.

- ▶▶ Disabled Disables this function. (Default)
- ▶▶ Profile1 Uses Profile 1 settings.
- ▶▶ Profile2 ^(Note) Uses Profile 2 settings.

⌄ System Memory Multiplier

Allows you to set the system memory multiplier. **Auto** sets memory multiplier according to memory SPD data. (Default: Auto)

⌄ Memory Frequency (MHz)

The first memory frequency value is the normal operating frequency of the memory being used; the second is the memory frequency that is automatically adjusted according to the **System Memory Multiplier** settings.

▶ Advanced Memory Settings

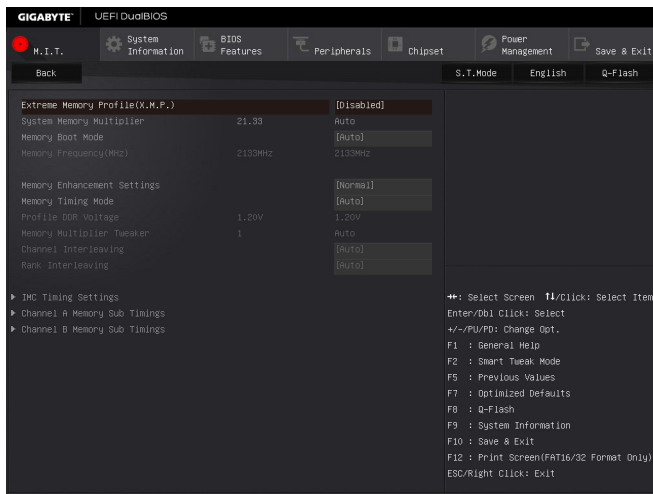

⌄ Extreme Memory Profile (X.M.P.) ^(Note), System Memory Multiplier, Memory Frequency (MHz)

The settings above are synchronous to those under the same items on the **Advanced Frequency Settings** menu.

(Note) This item is present only when you install a CPU and a memory module that support this feature.

☞ **Memory Boot Mode** (Note)

Provides memory detection and training methods.

- ▶▶ Auto Lets the BIOS automatically configure this setting. (Default)
- ▶▶ Enable Fast Boot Skip memory detection and training in some specific criteria for faster memory boot.
- ▶▶ Disable Fast Boot Detect and train memory at every single boot.

☞ **Memory Enhancement Settings**

Provides several memory performance enhancement settings: Normal (basic performance), Relax OC, Enhanced Stability, and Enhanced Performance. (Default: Normal)

☞ **Memory Timing Mode**

Manual and **Advanced Manual** allows the **Memory Multiplier Tweaker**, **Channel Interleaving**, **Rank Interleaving**, and memory timing settings below to be configurable. Options are: Auto (default), Manual, Advanced Manual.

☞ **Profile DDR Voltage**

When using a non-XMP memory module or **Extreme Memory Profile (X.M.P.)** is set to **Disabled**, the value is displayed according to your memory specification. When **Extreme Memory Profile (X.M.P.)** is set to **Profile1** or **Profile2**, the value is displayed according to the SPD data on the XMP memory.

☞ **Memory Multiplier Tweaker**

Provides different levels of memory auto-tuning. (Default: Auto)

☞ **Channel Interleaving**

Enables or disables memory channel interleaving. **Enabled** allows the system to simultaneously access different channels of the memory to increase memory performance and stability. **Auto** lets the BIOS automatically configure this setting. (Default: Auto)

☞ **Rank Interleaving**

Enables or disables memory rank interleaving. **Enabled** allows the system to simultaneously access different ranks of the memory to increase memory performance and stability. **Auto** lets the BIOS automatically configure this setting. (Default: Auto)

▶ **IMC Timing Settings**

This sub-menu provides options for tuning memory compatibility and stability.

▶ **Channel A/B Memory Sub Timings**

This sub-menu provides memory timing settings for each channel of memory. The respective timing setting screens are configurable only when **Memory Timing Mode** is set to **Manual** or **Advanced Manual**. Note: Your system may become unstable or fail to boot after you make changes on the memory timings. If this occurs, please reset the board to default values by loading optimized defaults or clearing the CMOS values.

(Note) This item is present only when you install a CPU and a memory module that support this feature.

▶ Advanced Voltage Settings

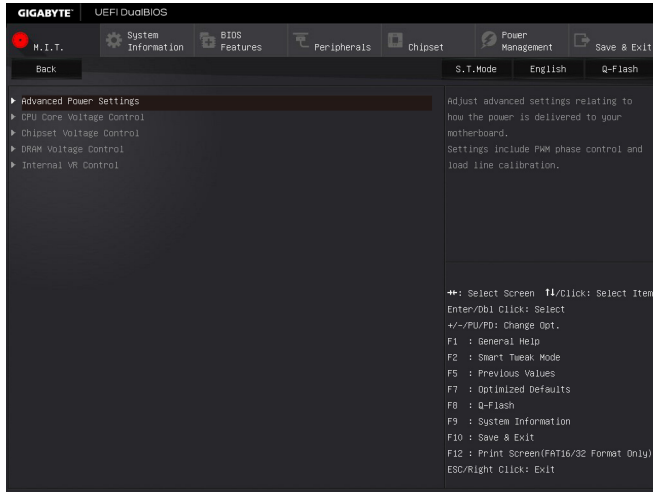

▶ Advanced Power Settings

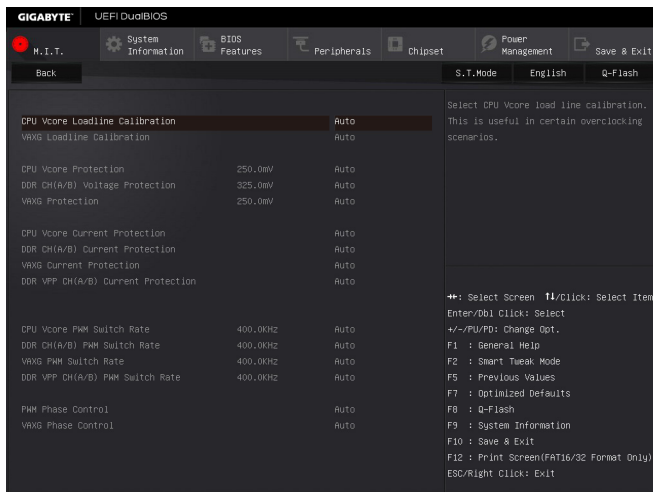

🔗 CPU Vcore Loadline Calibration

Allows you to set the Load-Line Calibration level for the CPU Vcore voltage. The levels are (from highest to lowest): Extreme, Turbo, High, Medium, Low, and Standard. Selecting a higher level keeps the CPU Vcore voltage more consistent with what is set in BIOS under heavy load. **Auto** lets the BIOS automatically configure this setting and sets the voltage following Intel's specifications. (Default: Auto)

⌄ **VAXG Loadline Calibration**

Allows you to set the Load-Line Calibration level for the CPU VAXG voltage. The levels are (from highest to lowest): Extreme, Turbo, High, Medium, Low, and Standard. Selecting a higher level keeps the CPU VAXG voltage more consistent with what is set in BIOS under heavy load. **Auto** lets the BIOS automatically configure this setting and sets the voltage following Intel's specifications. (Default: Auto)

⌄ **CPU Vcore Protection**

Allows you to set the over-current protection level for the CPU Vcore voltage. The adjustable range is from 150.0mV to 400.0mV. **Auto** lets the BIOS automatically configure this setting. (Default: Auto)

⌄ **DDR CH(A/B) Voltage Protection**

Allows you to set the over-current protection level for Channel A and Channel B memory voltage. The adjustable range is from 200.0mV to 500.0mV. **Auto** lets the BIOS automatically configure this setting. (Default: Auto)

⌄ **VAXG Protection**

Allows you to set the over-current protection level for the CPU VAXG voltage. The adjustable range is from 150.0mV to 400.0mV. **Auto** lets the BIOS automatically configure this setting. (Default: Auto)

⌄ **CPU Vcore Current Protection**

Allows you to set the over-current protection level for the CPU Vcore voltage.

- ▶▶ Auto Lets the BIOS automatically configure this setting. (Default)
- ▶▶ Standard~Extreme Selects Standard, Low, Medium, High, Turbo, or Extreme which represents different level of over-current protection for the CPU Vcore voltage.

⌄ **DDR CH(A/B) Current Protection**

Allows you to set the over-current protection level for Channel A and Channel B memory voltage.

- ▶▶ Auto Lets the BIOS automatically configure this setting. (Default)
- ▶▶ Standard~Extreme Selects Standard, Low, Medium, High, Turbo, or Extreme which represents different level of over-current protection for the memory voltage.

⌄ **VAXG Current Protection**

Allows you to set the over-current protection level for the CPU VAXG voltage.

- ▶▶ Auto Lets the BIOS automatically configure this setting. (Default)
- ▶▶ Standard~Extreme Selects Standard, Low, Medium, High, Turbo, or Extreme which represents different level of over-current protection for the memory voltage.

⌄ **DDR VPP CH(A/B) Current Protection**

Allows you to set the over-current protection level for memory VPP voltage.

- ▶▶ Auto Lets the BIOS automatically configure this setting. (Default)
- ▶▶ Standard~Extreme Selects Standard, Low, Medium, High, Turbo, or Extreme which represents different level of over-current protection for the memory VPP voltage.

⌄ **CPU Vcore PWM Switch Rate**

Allows you to set the PWM frequency for the CPU Vcore voltage. The adjustable range is from 300.0KHz to 500.0KHz. (Default: Auto)

⌄ **DDR CH(A/B) PWM Switch Rate**

Allows you to set the PWM frequency for Channel A and Channel B memory. The adjustable range is from 300.0KHz to 500.0KHz. (Default: Auto)

☞ **VAXG PWM Switch Rate**

Allows you to set the PWM frequency for the CPU VAXG voltage. The adjustable range is from 300.0KHz to 500.0KHz. (Default: Auto)

☞ **DDR VPP CH(A/B) PWM Switch Rate**

Allows you to set the PWM frequency for the memory VPP voltage. The adjustable range is from 300.0KHz to 500.0KHz. (Default: Auto)

☞ **PWM Phase Control**

Allows you to automatically change the PWM phase according to the CPU load. The power-saving levels are (from lowest to highest): eXm Perf (Extreme Performance), High Perf (High Performance), Perf (Performance), Balanced, Mid PWR (Mid Power), and Lite PWR (Light Power). **Auto** lets the BIOS automatically configure this setting. (Default: Auto)

☞ **VAXG Phase Control**

Allows you to automatically change the PWM phase of the CPU VAXG voltage according to the CPU load. The power-saving levels are (from lowest to highest): eXm Perf (Extreme Performance), High Perf (High Performance), Perf (Performance), Balanced, Mid PWR (Mid Power), and Lite PWR (Light Power). **Auto** lets the BIOS automatically configure this setting. (Default: Auto)

▶ **CPU Core Voltage Control**

This section provides CPU voltage control options.

▶ **Chipset Voltage Control**

This section provides Chipset voltage control options.

▶ **DRAM Voltage Control**

This section provides memory voltage control options.

▶ **Internal VR Control**

This section provides VR voltage control options.

PC Health Status

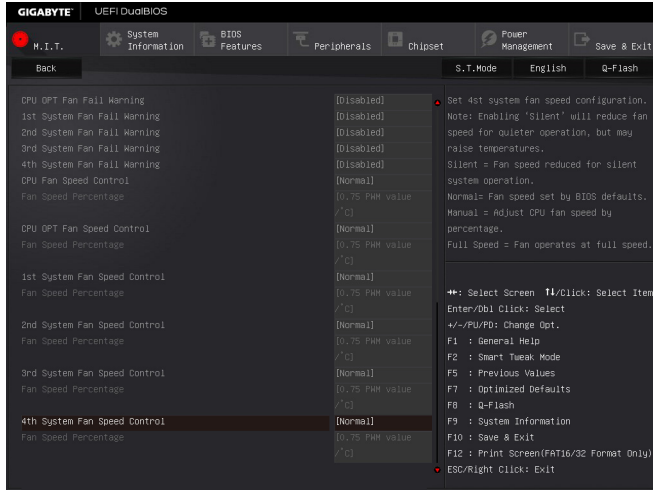
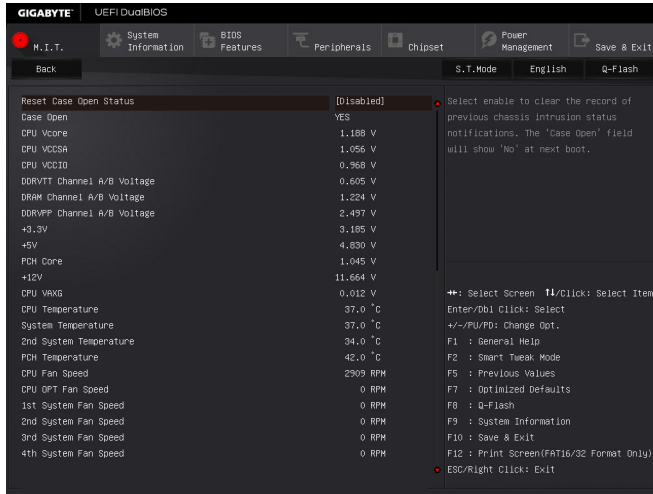

Reset Case Open Status

- ▶▶ Disabled Keeps or clears the record of previous chassis intrusion status. (Default)
- ▶▶ Enabled Clears the record of previous chassis intrusion status and the **Case Open** field will show "No" at next boot.

Case Open

Displays the detection status of the chassis intrusion detection device attached to the motherboard CI header. If the system chassis cover is removed, this field will show "Yes", otherwise it will show "No". To clear the chassis intrusion status record, set **Reset Case Open Status** to **Enabled**, save the settings to the CMOS, and then restart your system.

- ☞ **CPU Vcore/CPU VCCSA/CPU VCCIO/DDRVT Channel A/B Voltage/DRAM Channel A/B Voltage/DDRVP Channel A/B Voltage/+3.3V/+5V/PCH Core/+12V/CPU VAXG**
 Displays the current system voltages.
- ☞ **CPU/PCH Temperature**
 Displays current CPU/Chipset temperature.
- ☞ **System Temperature/2nd System Temperature**
 Displays current system temperatures detected by the system temperature sensors on the motherboard.
- ☞ **CPU/CPU OPT/System Fan Speed**
 Displays current CPU/CPU_OPT/system fan (SYS_FAN1~SYS_FAN4) speeds.
- ☞ **CPU/System/PCH Temperature Warning**
 Sets the warning threshold for CPU/system/Chipset temperature. When temperature exceeds the threshold, BIOS will emit warning sound. Options are: Disabled (default), 60°C/140°F, 70°C/158°F, 80°C/176°F, 90°C/194°F.
- ☞ **CPU/CPU OPT/System Fan Fail Warning**
 Allows the system to emit warning sound if the fan is not connected or fails. Check the fan condition or fan connection when this occurs. (Default: Disabled)
- ☞ **CPU Fan Speed Control (CPU_FAN Connector)**
 Allows you to determine whether to enable the fan speed control function and adjust the fan speed.

 - ▶▶ Normal Allows the fan to run at different speeds according to the CPU temperature. You can adjust the fan speed with System Information Viewer based on your system requirements. (Default)
 - ▶▶ Silent Allows the fan to run at slow speeds.
 - ▶▶ Manual Allows you to control the fan speed under the **Fan Speed Percentage** item.
 - ▶▶ Full Speed Allows the fan to run at full speeds.
- ☞ **Fan Speed Percentage**
 Allows you to control the fan speed. This item is configurable only when **CPU Fan Speed Control** is set to **Manual**. Options are: 0.75 PWM value /°C ~ 2.50 PWM value /°C.
- ☞ **CPU OPT Fan Speed Control (CPU_OPT Connector)**
 Allows you to determine whether to enable the fan speed control function and adjust the fan speed.

 - ▶▶ Normal Allows the fan to run at different speeds according to the CPU temperature. You can adjust the fan speed with System Information Viewer based on your system requirements. (Default)
 - ▶▶ Silent Allows the fan to run at slow speeds.
 - ▶▶ Manual Allows you to control the fan speed under the **Fan Speed Percentage** item.
 - ▶▶ Full Speed Allows the fan to run at full speeds.
- ☞ **Fan Speed Percentage**
 Allows you to control the fan speed. This item is configurable only when **CPU OPT Fan Speed Control** is set to **Manual**. Options are: 0.75 PWM value /°C ~ 2.50 PWM value /°C.
- ☞ **1st System Fan Speed Control (SYS_FAN1 Connector)**
 Allows you to determine whether to enable the fan speed control function and adjust the fan speed.

 - ▶▶ Normal Allows the fan to run at different speeds according to the system temperature. You can adjust the fan speed with System Information Viewer based on your system requirements. (Default)
 - ▶▶ Silent Allows the fan to run at slow speeds.
 - ▶▶ Manual Allows you to control the fan speed under the **Fan Speed Percentage** item.
 - ▶▶ Full Speed Allows the fan to run at full speeds.

☞ **Fan Speed Percentage**

Allows you to control the fan speed. This item is configurable only when **1st System Fan Speed Control** is set to **Manual**. Options are: 0.75 PWM value /°C ~ 2.50 PWM value /°C.

☞ **2nd System Fan Speed Control (SYS_FAN2 Connector)**

Allows you to determine whether to enable the fan speed control function and adjust the fan speed.

- ▶▶ Normal Allows the fan to run at different speeds according to the system temperature. You can adjust the fan speed with System Information Viewer based on your system requirements. (Default)
- ▶▶ Silent Allows the fan to run at slow speeds.
- ▶▶ Manual Allows you to control the fan speed under the **Fan Speed Percentage** item.
- ▶▶ Full Speed Allows the fan to run at full speeds.

☞ **Fan Speed Percentage**

Allows you to control the fan speed. This item is configurable only when **2nd System Fan Speed Control** is set to **Manual**. Options are: 0.75 PWM value /°C ~ 2.50 PWM value /°C.

☞ **3rd System Fan Speed Control (SYS_FAN3 Connector)**

Allows you to determine whether to enable the fan speed control function and adjust the fan speed.

- ▶▶ Normal Allows the fan to run at different speeds according to the system temperature. You can adjust the fan speed with System Information Viewer based on your system requirements. (Default)
- ▶▶ Silent Allows the fan to run at slow speeds.
- ▶▶ Manual Allows you to control the fan speed under the **Fan Speed Percentage** item.
- ▶▶ Full Speed Allows the fan to run at full speeds.

☞ **Fan Speed Percentage**

Allows you to control the fan speed. This item is configurable only when **3rd System Fan Speed Control** is set to **Manual**. Options are: 0.75 PWM value /°C ~ 2.50 PWM value /°C.

☞ **4th System Fan Speed Control (SYS_FAN4 Connector)**

Allows you to determine whether to enable the fan speed control function and adjust the fan speed.

- ▶▶ Normal Allows the fan to run at different speeds according to the system temperature. You can adjust the fan speed with System Information Viewer based on your system requirements. (Default)
- ▶▶ Silent Allows the fan to run at slow speeds.
- ▶▶ Manual Allows you to control the fan speed under the **Fan Speed Percentage** item.
- ▶▶ Full Speed Allows the fan to run at full speeds.

☞ **Fan Speed Percentage**

Allows you to control the fan speed. This item is configurable only when **4th System Fan Speed Control** is set to **Manual**. Options are: 0.75 PWM value /°C ~ 2.50 PWM value /°C.

► Miscellaneous Settings

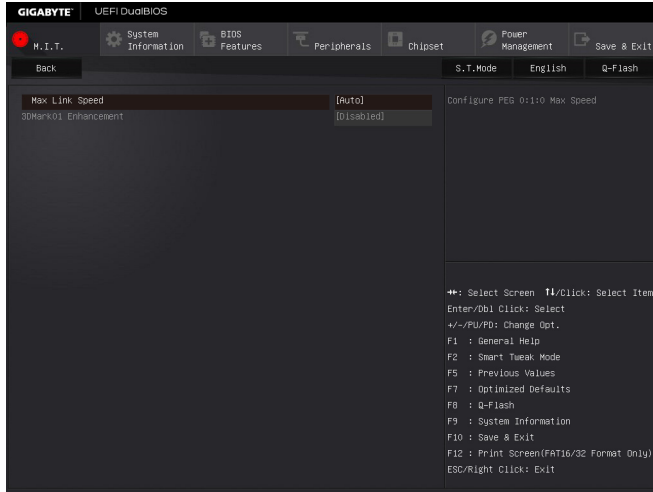

🔗 Max Link Speed

Allows you to set the operation mode of the PCI Express slots to Gen 1, Gen 2, or Gen 3. Actual operation mode is subject to the hardware specification of each slot. **Auto** lets the BIOS automatically configure this setting. (Default: Auto)

🔗 3DMark01 Enhancement

Allows you to determine whether to enhance some legacy benchmark performance. (Default: Disabled)

2-4 System Information

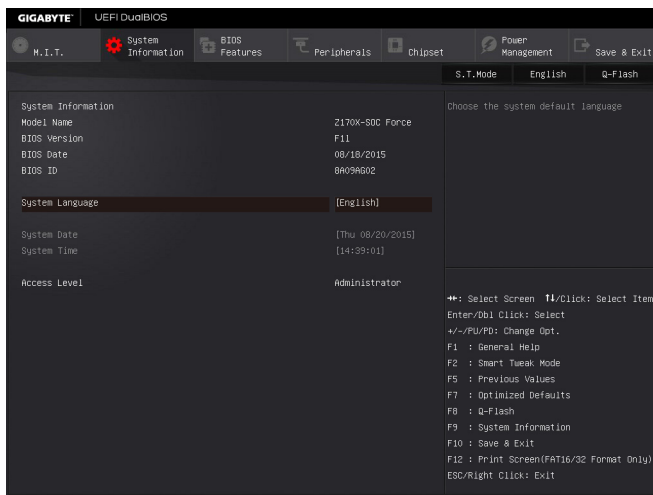

This section provides information on your motherboard model and BIOS version. You can also select the default language used by the BIOS and manually set the system time.

System Language

Selects the default language used by the BIOS.

System Date

Sets the system date. The date format is week (read-only), month, date, and year. Use <Enter> to switch between the Month, Date, and Year fields and use the <Page Up> or <Page Down> key to set the desired value.

System Time

Sets the system time. The time format is hour, minute, and second. For example, 1 p.m. is 13:00:00. Use <Enter> to switch between the Hour, Minute, and Second fields and use the <Page Up> or <Page Down> key to set the desired value.

Access Level

Displays the current access level depending on the type of password protection used. (If no password is set, the default will display as **Administrator**.) The Administrator level allows you to make changes to all BIOS settings; the User level only allows you to make changes to certain BIOS settings but not all.

2-5 BIOS Features

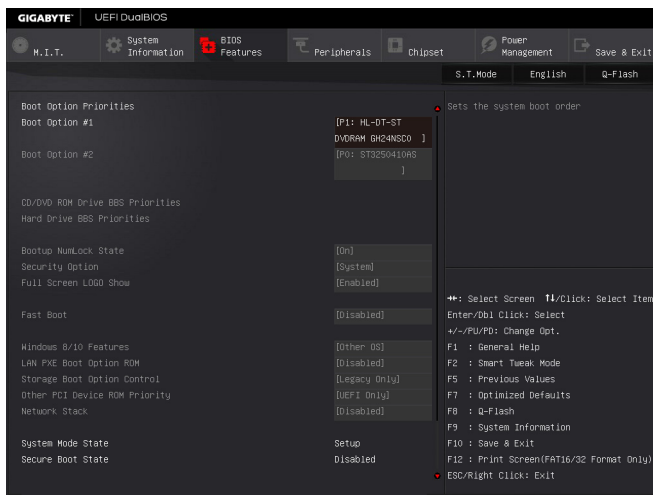

☞ **Boot Option Priorities**

Specifies the overall boot order from the available devices. Removable storage devices that support GPT format will be prefixed with "UEFI:" string on the boot device list. To boot from an operating system that supports GPT partitioning, select the device prefixed with "UEFI:" string.

Or if you want to install an operating system that supports GPT partitioning such as Windows 7 64-bit, select the optical drive that contains the Windows 7 64-bit installation disk and is prefixed with "UEFI:" string.

☞ **Hard Drive/CD/DVD ROM Drive/Floppy Drive/Network Device BBS Priorities**

Specifies the boot order for a specific device type, such as hard drives, optical drives, floppy disk drives, and devices that support Boot from LAN function, etc. Press <Enter> on this item to enter the submenu that presents the devices of the same type that are connected. This item is present only if at least one device for this type is installed.

☞ **Bootup NumLock State**

Enables or disables Numlock feature on the numeric keypad of the keyboard after the POST. (Default: On)

☞ **Security Option**

Specifies whether a password is required every time the system boots, or only when you enter BIOS Setup. After configuring this item, set the password(s) under the **Administrator Password/User Password** item.

▶▶ Setup A password is only required for entering the BIOS Setup program.

▶▶ System A password is required for booting the system and for entering the BIOS Setup program. (Default)

☞ **Full Screen LOGO Show**

Allows you to determine whether to display the GIGABYTE Logo at system startup. **Disabled** skips the GIGABYTE Logo when the system starts up. (Default: Enabled)

☞ **Fast Boot**

Enables or disables Fast Boot to shorten the OS boot process. **Ultra Fast** provides the fastest bootup speed. (Default: Disabled)

☞ **SATA Support**

- ▶▶ All Sata Devices All SATA devices are functional in the operating system and during the POST. (Default)
- ▶▶ Last Boot HDD Only Except for the previous boot drive, all SATA devices are disabled before the OS boot process completes.

This item is configurable only when **Fast Boot** is set to **Enabled** or **Ultra Fast**.

☞ **VGA Support**

Allows you to select which type of operating system to boot.

- ▶▶ Auto Enables legacy option ROM only.
- ▶▶ EFI Driver Enables EFI option ROM. (Default)

This item is configurable only when **Fast Boot** is set to **Enabled** or **Ultra Fast**.

☞ **USB Support**

- ▶▶ Disabled All USB devices are disabled before the OS boot process completes.
- ▶▶ Full Initial All USB devices are functional in the operating system and during the POST.
- ▶▶ Partial Initial Part of the USB devices are disabled before the OS boot process completes. (Default)

This item is configurable only when **Fast Boot** is set to **Enabled**. This function is disabled when **Fast Boot** is set to **Ultra Fast**.

☞ **PS2 Devices Support**

- ▶▶ Disabled All PS/2 devices are disabled before the OS boot process completes.
- ▶▶ Enabled All PS/2 devices are functional in the operating system and during the POST. (Default)

This item is configurable only when **Fast Boot** is set to **Enabled**. This function is disabled when **Fast Boot** is set to **Ultra Fast**.

☞ **NetWork Stack Driver Support**

- ▶▶ Disabled Disables booting from the network. (Default)
- ▶▶ Enabled Enables booting from the network.

This item is configurable only when **Fast Boot** is set to **Enabled** or **Ultra Fast**.

☞ **Next Boot After AC Power Loss**

- ▶▶ Normal Boot Enables normal bootup upon the return of the AC power. (Default)
- ▶▶ Fast Boot Keeps the Fast Boot settings upon the return of the AC power.

This item is configurable only when **Fast Boot** is set to **Enabled** or **Ultra Fast**.

☞ **Windows 8/10 Features**

Allows you to select the operating system to be installed. (Default: Other OS)

☞ **CSM Support**

Enables or disables UEFI CSM (Compatibility Support Module) to support a legacy PC boot process.

- ▶▶ Enabled Enables UEFI CSM. (Default)
- ▶▶ Disabled Disables UEFI CSM and supports UEFI BIOS boot process only.

This item is configurable only when **Windows 8/10 Features** is set to **Windows 8/10** or **Windows 8/10 WHQL**.

☞ **LAN PXE Boot Option ROM**

Allows you to select whether to enable the legacy option ROM for the LAN controller. (Default: Disabled)

This item is configurable only when **CSM Support** is set to **Enabled**.

☞ **Storage Boot Option Control**

Allows you to select whether to enable the UEFI or legacy option ROM for the storage device controller.

- ▶▶ Disabled Disables option ROM.
- ▶▶ Legacy Only Enables legacy option ROM only. (Default)
- ▶▶ UEFI Only Enables UEFI option ROM only.

This item is configurable only when **CSM Support** is set to **Enabled**.

☞ **Other PCI Device ROM Priority**

Allows you to select whether to enable the UEFI or Legacy option ROM for the PCI device controller other than the LAN, storage device, and graphics controllers.

- ▶▶ Disabled Disables option ROM.
- ▶▶ Legacy Only Enables legacy option ROM only.
- ▶▶ UEFI Only Enables UEFI option ROM only. (Default)

This item is configurable only when **CSM Support** is set to **Enabled**.

☞ **Network Stack**

Disables or enables booting from the network to install a GPT format OS, such as installing the OS from the Windows Deployment Services server. (Default: Disabled)

☞ **IPv4 PXE Support**

Enables or disables IPv4 PXE Support. This item is configurable only when **Network Stack** is enabled.

☞ **IPv6 PXE Support**

Enables or disables IPv6 PXE Support. This item is configurable only when **Network Stack** is enabled.

☞ **Administrator Password**

Allows you to configure an administrator password. Press <Enter> on this item, type the password, and then press <Enter>. You will be requested to confirm the password. Type the password again and press <Enter>. You must enter the administrator password (or user password) at system startup and when entering BIOS Setup. Differing from the user password, the administrator password allows you to make changes to all BIOS settings.

☞ **User Password**

Allows you to configure a user password. Press <Enter> on this item, type the password, and then press <Enter>. You will be requested to confirm the password. Type the password again and press <Enter>. You must enter the administrator password (or user password) at system startup and when entering BIOS Setup. However, the user password only allows you to make changes to certain BIOS settings but not all.

To cancel the password, press <Enter> on the password item and when requested for the password, enter the correct one first. When prompted for a new password, press <Enter> without entering any password. Press <Enter> again when prompted to confirm.

NOTE: Before setting the User Password, be sure to set the Administrator Password first.

2-6 Peripherals

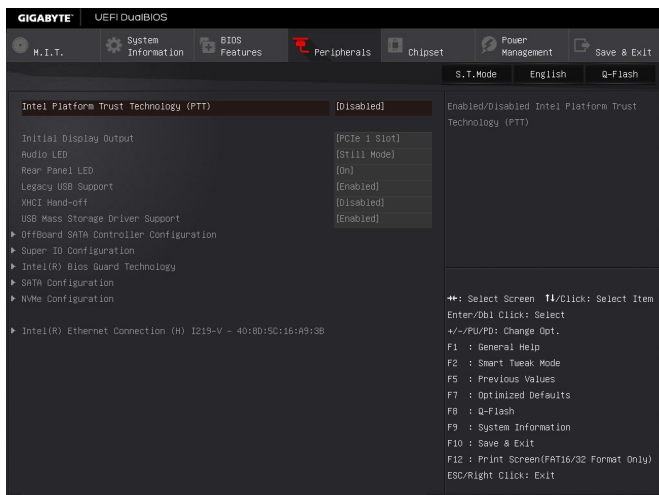

Intel Platform Trust Technology (PTT)

Enables or disables Intel® PTT Technology. (Default: Disabled)

Initial Display Output

Specifies the first initiation of the monitor display from the installed PCI Express graphics card or the onboard graphics.

- ▶▶ IGFX Sets the onboard graphics as the first display.
- ▶▶ PCIe 1 Slot Sets the graphics card on the PCIEX16_1 slot as the first display. (Default)
- ▶▶ PCIe 2 Slot Sets the graphics card on the PCIEX8_1 slot as the first display.
- ▶▶ PCIe 3 Slot Sets the graphics card on the PCIEX16_2 slot as the first display.
- ▶▶ PCIe 4 Slot Sets the graphics card on the PCIEX8_2 slot as the first display.

Audio LED

Enables or disables the onboard audio LED function.

- ▶▶ Off Disables this function.
- ▶▶ Still Mode The LEDs stay constantly on. (Default)
- ▶▶ Beat Mode The brightness of the LED changes according to the music rhythm.
- ▶▶ Pulse Mode The brightness of the LED changes slowly and smoothly like breath.

Rear Panel LED

Enables or disables the audio LED on the rear panel I/O shield.

- ▶▶ On The LED will light and follow the behavior of the onboard audio LEDs. (Default)
- ▶▶ Off Disables this function.

Legacy USB Support

Allows USB keyboard/mouse to be used in MS-DOS. (Default: Enabled)

XHCI Hand-off

Determines whether to enable XHCI Hand-off feature for an operating system without XHCI Hand-off support. (Default: Disabled)

USB Mass Storage Driver Support

Enables or disables support for USB storage devices. (Default: Enabled)

☞ **USB Storage Devices**

Displays a list of connected USB mass storage devices. This item appears only when a USB storage device is installed.

▶ **OffBoard SATA Controller Configuration**

Displays information on your M.2 PCIe SSD if installed.

▶ **Trusted Computing 2.0**

This sub-menu appears only when **Intel Platform Trust Technology** is set to **Enabled**.

☞ **Security Device Support**

Enables or disables Trusted Platform Module (TPM). (Default: Enabled)

☞ **Pending operation**

To clear TPM related settings, set this item to **TPM Clear**. (Default: None)

☞ **TPM 2.0 InterfaceType**

Allows you to select the communication interface for the TPM 2.0 device. Set to **External TPM2.0** if you install an Infineon TPM 2.0 module (optional). (Default: PTT)

☞ **Device Select**

Allows you to select whether to support TPM 1.2 or TPM 2.0 device. **Auto** lets the BIOS automatically configure this setting. (Default: Auto)

▶ **Super IO Configuration**

☞ **Serial Port 1**

Enables or disables the onboard serial port. (Default: Enabled)

▶ **Intel(R) Bios Guard Technology**

Enables or disables the Intel® BIOS Guard feature, which protects the BIOS from malicious attacks.

▶ **SATA Configuration**

☞ **SATA Controller(s)**

Enables or disables the integrated SATA controllers. (Default: Enabled)

☞ **SATA Mode Selection**

Enables or disables RAID for the SATA controllers integrated in the Chipset or configures the SATA controllers to AHCI mode.

▶▶ RAID Enables RAID for the SATA controller.

▶▶ AHCI Configures the SATA controllers to AHCI mode. Advanced Host Controller Interface (AHCI) is an interface specification that allows the storage driver to enable advanced Serial ATA features such as Native Command Queuing and hot plug. (Default)

☞ **Aggressive LPM Support**

Enables or disables the power saving feature, ALPM (Aggressive Link Power Management), for the Chipset SATA controllers. (Default: Enabled)

☞ **Port 0/1/2/3/4/5**

Enables or disables each SATA port. (Default: Enabled)

☞ **Hot plug**

Enables or disable the hot plug capability for each SATA port. (Default: Disabled)

↪ **External SATA**

Enables or disables support for external SATA devices. (Default: Disabled)

▶ **NVMe Configuration**

Displays information on your M.2 NVME PCIe SSD if installed.

▶ **Intel(R) Ethernet Network Connection**

This sub-menu provides information on LAN configuration and related configuration options.

2-7 Chipset

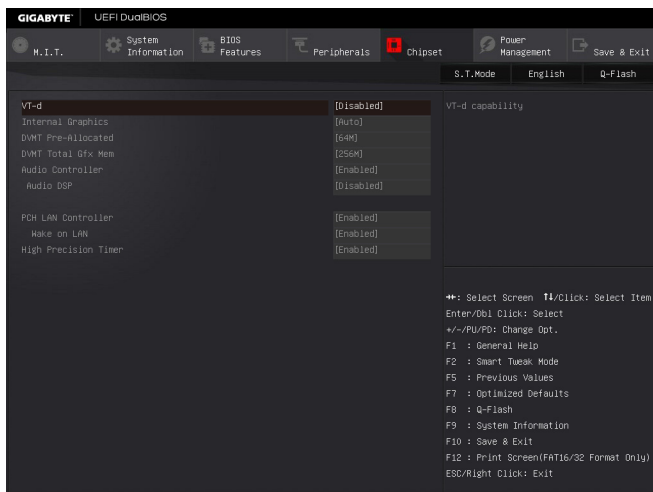

- ⊞ **VT-d (Note)**
Enables or disables Intel® Virtualization Technology for Directed I/O. (Default: Disabled)
- ⊞ **Internal Graphics**
Enables or disables the onboard graphics function. (Default: Auto)
- ⊞ **DVMT Pre-Allocated**
Allows you to set the onboard graphics memory size. Options are: 32M–512M. (Default: 64M)
- ⊞ **DVMT Total Gfx Mem**
Allows you to allocate the DVMT memory size of the onboard graphics. Options are: 128M, 256M, MAX. (Default: 256M)
- ⊞ **Audio Controller**
Enables or disables the onboard audio function. (Default: Enabled)
If you wish to install a 3rd party add-in audio card instead of using the onboard audio, set this item to **Disabled**.
- ⊞ **Audio DSP**
Enables or disables the DSP functionality of the PCH audio unit. (Default: Disabled)
- ⊞ **PCH LAN Controller**
Enables or disables the onboard LAN function. (Default: Enabled)
If you wish to install a 3rd party add-in network card instead of using the onboard LAN, set this item to **Disabled**.
- ⊞ **Wake on LAN**
Enables or disables the wake on LAN function. (Default: Enabled)
- ⊞ **High Precision Timer**
Enables or disables High Precision Event Timer (HPET) in the operating system. (Default: Enabled)

(Note) This item is present only when you install a CPU that supports this feature. For more information about Intel® CPUs' unique features, please visit Intel's website.

2-8 Power Management

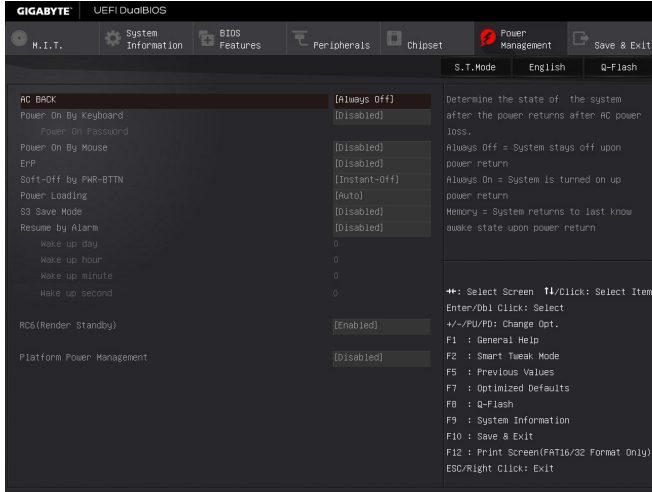

AC BACK

Determines the state of the system after the return of power from an AC power loss.

- ▶▶ Always Off The system stays off upon the return of the AC power. (Default)
- ▶▶ Always On The system is turned on upon the return of the AC power.
- ▶▶ Memory The system returns to its last known awake state upon the return of the AC power.

Power On By Keyboard

Allows the system to be turned on by a PS/2 keyboard wake-up event.

Note: To use this function, you need an ATX power supply providing at least 1A on the +5VSB lead.

- ▶▶ Disabled Disables this function. (Default)
- ▶▶ Any Key Press any key to turn on the system.
- ▶▶ Keyboard 98 Press POWER button on the Windows 98 keyboard to turn on the system.
- ▶▶ Password Set a password with 1~5 characters to turn on the system.

Power On Password

Set the password when **Power On By Keyboard** is set to **Password**.

Press <Enter> on this item and set a password with up to 5 characters and then press <Enter> to accept. To turn on the system, enter the password and press <Enter>.

Note: To cancel the password, press <Enter> on this item. When prompted for the password, press <Enter> again without entering the password to clear the password settings.

Power On By Mouse

Allows the system to be turned on by a PS/2 mouse wake-up event.

Note: To use this function, you need an ATX power supply providing at least 1A on the +5VSB lead.

- ▶▶ Disabled Disables this function. (Default)
- ▶▶ Move Move the mouse to turn on the system.
- ▶▶ Double Click Double click on left button on the mouse to turn on the system.

☞ **ErP**

Determines whether to let the system consume least power in S5 (shutdown) state. (Default: Disabled)

Note: When this item is set to **Enabled**, the following functions will become unavailable: Resume by Alarm, PME event wake up, power on by mouse, power on by keyboard, and wake on LAN.

☞ **Soft-Off by PWR-BTTN**

Configures the way to turn off the computer in MS-DOS mode using the power button.

▶▶ Instant-Off Press the power button and then the system will be turned off instantly. (Default)

▶▶ Delay 4 Sec. Press and hold the power button for 4 seconds to turn off the system. If the power button is pressed for less than 4 seconds, the system will enter suspend mode.

☞ **Power Loading**

Enables or disables dummy load. When the power supply is at low load, a self-protection will activate causing it to shutdown or fail. If this occurs, please set to **Enabled**. **Auto** lets the BIOS automatically configure this setting. (Default: Auto)

☞ **S3 Save Mode**

Allows you to determine whether to let idle devices to enter power-saving mode in system S3 state. (Default: Disabled)

☞ **Resume by Alarm**

Determines whether to power on the system at a desired time. (Default: Disabled)

If enabled, set the date and time as following:

▶▶ Wake up day: Turn on the system at a specific time on each day or on a specific day in a month.

▶▶ Wake up hour/minute/second: Set the time at which the system will be powered on automatically.

Note: When using this function, avoid inadequate shutdown from the operating system or removal of the AC power, or the settings may not be effective.

☞ **RC6(Render Standby)**

Allows you to determine whether to let the onboard graphics enter standby mode to decrease power consumption. (Default: Enabled)

☞ **Platform Power Management**

Enables or disables the Active State Power Management function (ASPM). (Default: Disabled)

☞ **PEG ASPM**

Allows you to configure the ASPM mode for the device connected to the CPU PEG bus. This item is configurable only when **Platform Power Management** is set to **Enabled**. (Default: Enabled)

☞ **PCH ASPM**

Allows you to configure the ASPM mode for the device connected to Chipset's PCI Express bus. This item is configurable only when **Platform Power Management** is set to **Enabled**. (Default: Enabled)

☞ **DMI Link ASPM Control**

Allows you to configure the ASPM mode for both CPU side and Chipset side of the DMI link. This item is configurable only when **Platform Power Management** is set to **Enabled**. (Default: Enabled)

2-9 Save & Exit

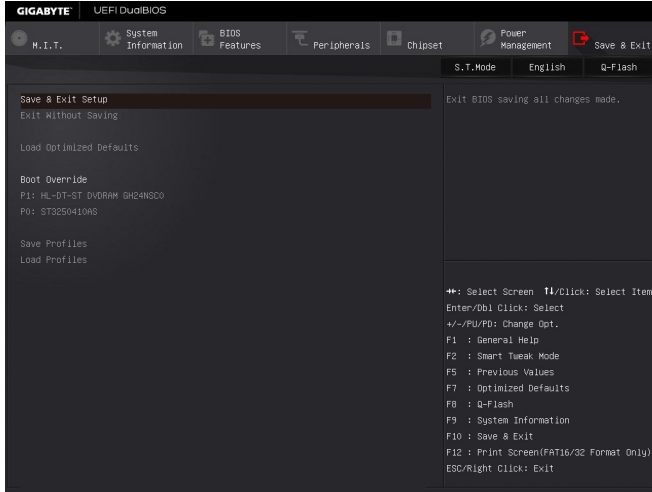

Save & Exit Setup

Press <Enter> on this item and select **Yes**. This saves the changes to the CMOS and exits the BIOS Setup program. Select **No** or press <Esc> to return to the BIOS Setup Main Menu.

Exit Without Saving

Press <Enter> on this item and select **Yes**. This exits the BIOS Setup without saving the changes made in BIOS Setup to the CMOS. Select **No** or press <Esc> to return to the BIOS Setup Main Menu.

Load Optimized Defaults

Press <Enter> on this item and select **Yes** to load the optimal BIOS default settings. The BIOS defaults settings help the system to operate in optimum state. Always load the Optimized defaults after updating the BIOS or after clearing the CMOS values.

Boot Override

Allows you to select a device to boot immediately. Press <Enter> on the device you select and select **Yes** to confirm. Your system will restart automatically and boot from that device.

Save Profiles

This function allows you to save the current BIOS settings to a profile. You can create up to 8 profiles and save as Setup Profile 1~ Setup Profile 8. Or you can select **Select File in HDD/USB/FDD** to save the profile to your storage device. **Select TAG Profile** allows you to specify one of Profile 1 to Profile 8 as TAG Profile, which will be loaded when you press the OC Tag button on the motherboard.

Load Profiles

If your system becomes unstable and you have loaded the BIOS default settings, you can use this function to load the BIOS settings from a profile created before, without the hassles of reconfiguring the BIOS settings. First select the profile you wish to load and then press <Enter> to complete. You can select **Select File in HDD/FDD/USB** to input the profile previously created from your storage device or load the profile automatically created by the BIOS, such as reverting the BIOS settings to the last settings that worked properly (last known good record).

Chapter 3 Configuring a RAID Set

RAID Levels

	RAID 0	RAID 1	RAID 5	RAID 10
Minimum Number of Hard Drives	≥2	2	≥3	≥4
Array Capacity	Number of hard drives * Size of the smallest drive	Size of the smallest drive	(Number of hard drives - 1) * Size of the smallest drive	(Number of hard drives/2) * Size of the smallest drive
Fault Tolerance	No	Yes	Yes	Yes

To create a RAID set, follow the steps below:

- Install SATA hard drive(s) in your computer.
- Configure SATA controller mode in BIOS Setup.
- Configure a RAID array in RAID BIOS. (Note 1)
- Install the SATA RAID/AHCI driver and operating system.

Before you begin, please prepare the following items:

- At least two SATA hard drives or M.2 SSDs (Note 2) (to ensure optimal performance, it is recommended that you use two hard drives with identical model and capacity). (Note 3)
- A Windows setup disk.
- Motherboard driver disk.
- A USB thumb drive.

3-1 Configuring SATA Controllers

A. Installing hard drives

Connect the SATA signal cables to SATA hard drives and the Intel® Chipset controlled SATA ports (SATA3 0~5) on the motherboard. Then connect the power connectors from your power supply to the hard drives. Or install your M.2 SSD(s) in the M.2 connector(s) on the motherboards.

(Note 1) Skip this step if you do not want to create RAID array on the SATA controller.

(Note 2) An M.2 PCIe SSD cannot be used to set up a RAID set either with an M.2 SATA SSD or a SATA hard drive.

(Note 3) Refer to Chapter 1, "Internal Connectors," "M.2 Socket 3 Connector," for the configuration tables of SATA hard drives and M.2 SSDs.

B. Configuring SATA controller mode in BIOS Setup

Make sure to configure the SATA controller mode correctly in system BIOS Setup.

Step 1:

Turn on your computer and press <Delete> to enter BIOS Setup during the POST (Power-On Self-Test). Go to **Peripherals\SATA Configuration**, make sure **SATA Controller(s)** is enabled. To create RAID, set **SATA Mode Selection** to **RAID** (Figure 1).

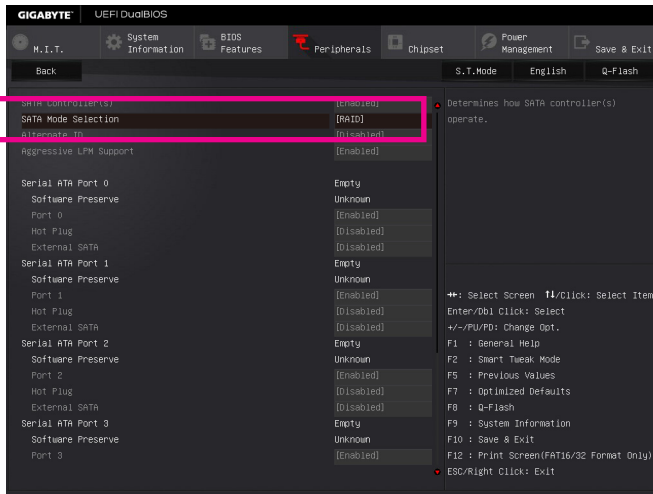

Figure 1

Step 2:

If you want to configure UEFI RAID, follow the steps in "C-1." To enter the legacy RAID ROM, save the settings and exit BIOS Setup. Refer to "C-2" for more information.



The BIOS Setup menus described in this section may differ from the exact settings for your motherboard. The actual BIOS Setup menu options you will see shall depend on the motherboard you have and the BIOS version.

C-1. UEFI RAID Configuration

Only Windows 10/8.1 64-bit supports UEFI RAID configuration.

Step 1:

In BIOS Setup, go to **BIOS Features** and set **Windows 8/10 Features** to **Windows 8/10** and **CSM Support** to **Disabled** (Figure 2). Save the changes and exit BIOS Setup.

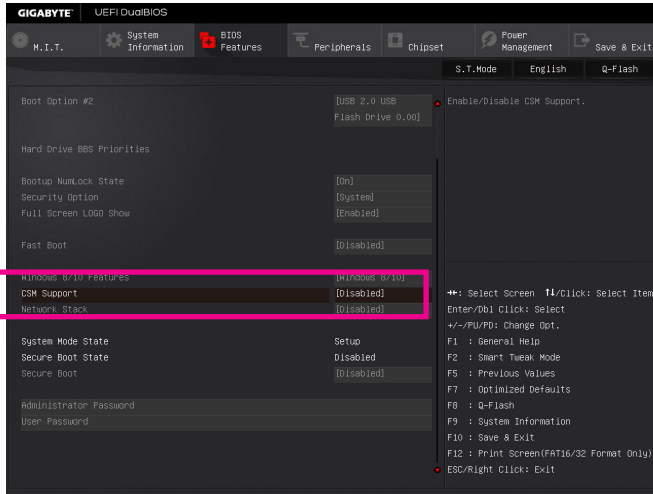

Figure 2

Step 2:

After the system reboot, enter BIOS Setup again. Then enter the **Peripherals/Intel(R) Rapid Storage Technology** sub-menu (Figure 3).

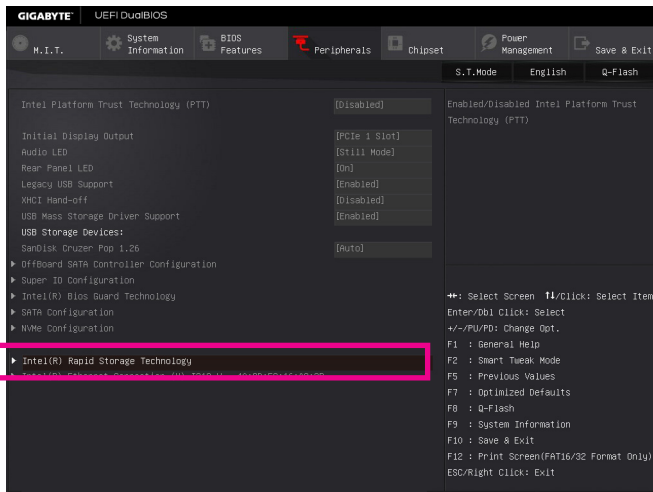

Figure 3

Step 3:

On the **Intel(R) Rapid Storage Technology** menu, press <Enter> on **Create RAID Volume** to enter the **Create RAID Volume** screen. Enter a volume name with 1~16 letters (letters cannot be special characters) under the **Name** item and press <Enter>. Then, select a RAID level (Figure 4). RAID levels supported include RAID 0, RAID 1, RAID 10, and RAID 5 (the selections available depend on the number of the hard drives being installed). Next, use the down arrow key to move to **Select Disks**.

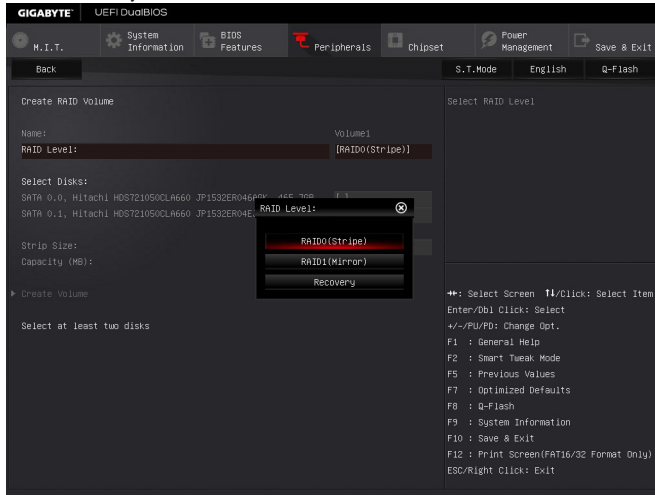

Figure 4

Step 4:

Under **Select Disks** item, select the hard drives to be included in the RAID array. Press the <Space> key on the hard drives to be selected (selected hard drives are marked with "X"). Then set the stripe block size (Figure 5). The stripe block size can be set from 4 KB to 128 KB. Once you have selected the stripe block size, set the volume capacity.

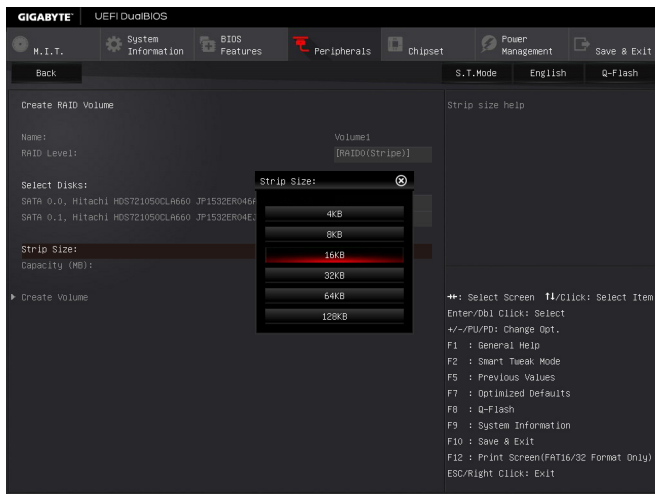

Figure 5

Step 5:

After setting the capacity, move to **Create Volume** and press <Enter> to begin. (Figure 6)

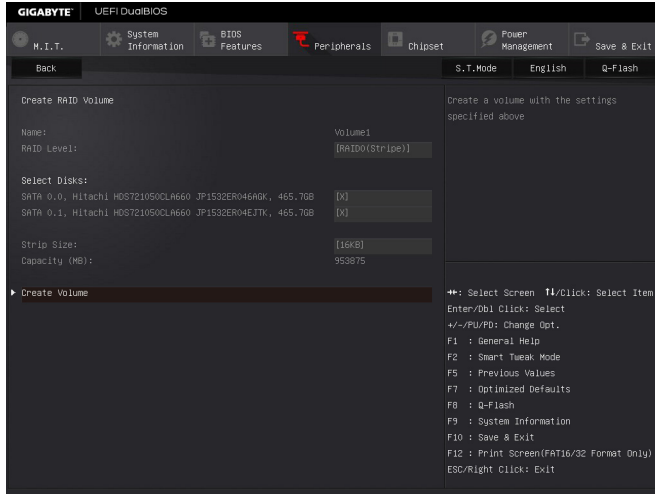

Figure 6

After completing, you'll be brought back to the **Intel(R) Rapid Storage Technology** screen. Under **RAID Volumes** you can see the new RAID volume. To see more detailed information, press <Enter> on the volume to check for information on RAID level, stripe block size, array name, and array capacity, etc. (Figure 7)

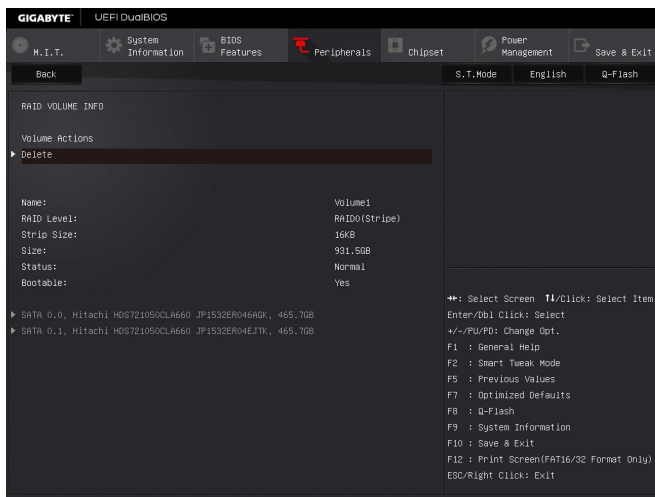

Figure 7

Delete RAID Volume

To delete a RAID array, press <Enter> on the volume to be deleted on the **Intel(R) Rapid Storage Technology** screen. After entering the **RAID VOLUME INFO** screen, press <Enter> on **Delete** to enter the **Delete** screen. Press <Enter> on **Yes** (Figure 8).

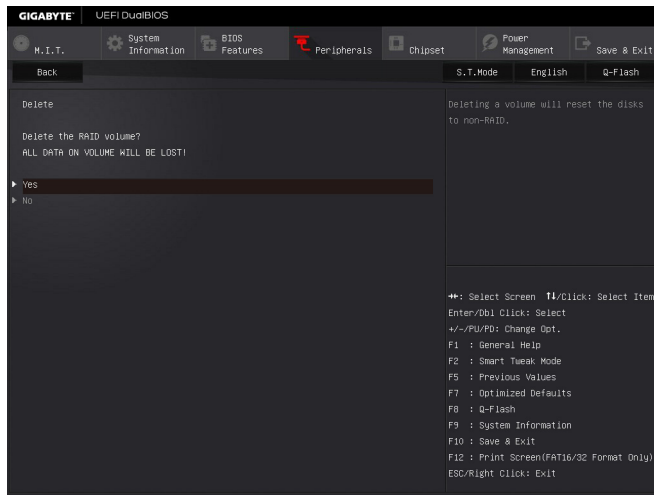

Figure 8

C-2. Configuring Legacy RAID ROM

Enter the Intel® legacy RAID BIOS setup utility to configure a RAID array. Skip this step and proceed with the installation of Windows operating system for a non-RAID configuration.

Step 1:

After the POST memory test begins and before the operating system boot begins, look for a message which says "Press <Ctrl-I> to enter Configuration Utility" (Figure 9). Press <Ctrl> + <I> to enter the RAID Configuration Utility.

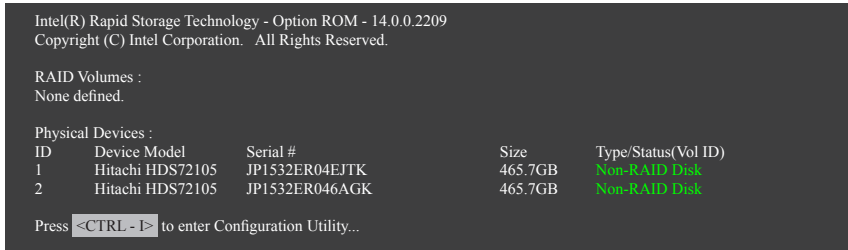

Figure 9

Step 2:

After you press <Ctrl> + <I>, the MAIN MENU screen will appear (Figure 10).

Create RAID Volume

If you want to create a RAID array, select **Create RAID Volume** in **MAIN MENU** and press <Enter>.

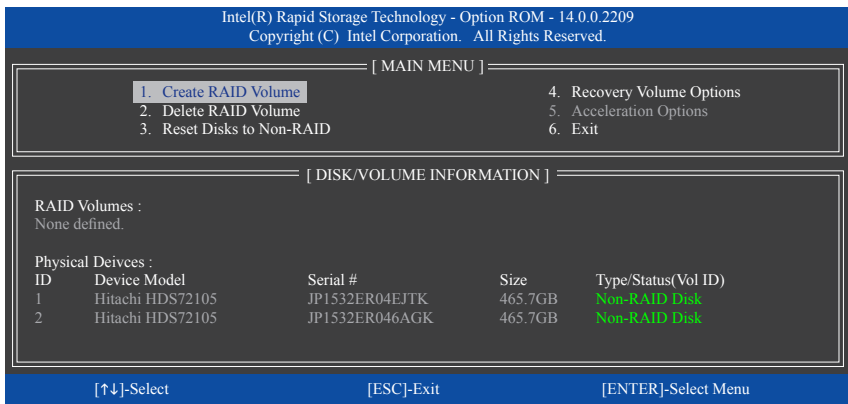

Figure 10

Step 3:

After entering the **CREATE VOLUME MENU** screen, enter a volume name with 1~16 letters (letters cannot be special characters) under the **Name** item and press <Enter>. Then, select a RAID level (Figure 11). RAID levels supported include RAID 0, RAID 1, RAID 10, and RAID 5 (the selections available depend on the number of the hard drives being installed). Press <Enter> to proceed.

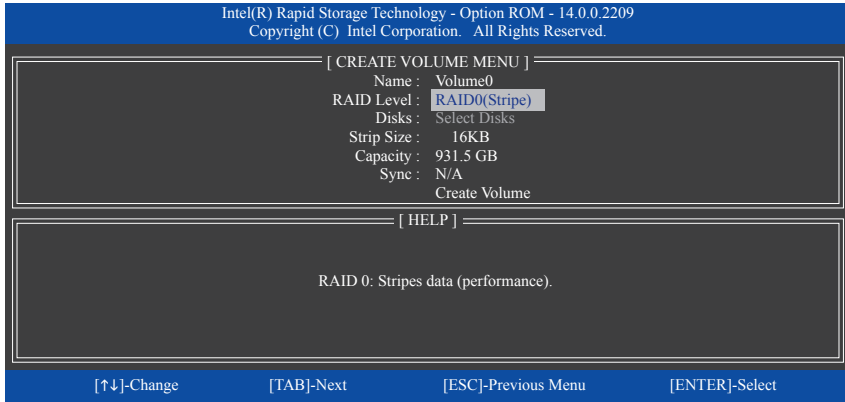

Figure 11

Step 4:

Under **Disks** item, select the hard drives to be included in the RAID array. If only two hard drives are installed, they will be automatically assigned to the array. Set the stripe block size (Figure 12) if necessary. The stripe block size can be set from 4 KB to 128 KB. Once you have selected the stripe block size, press <Enter>.

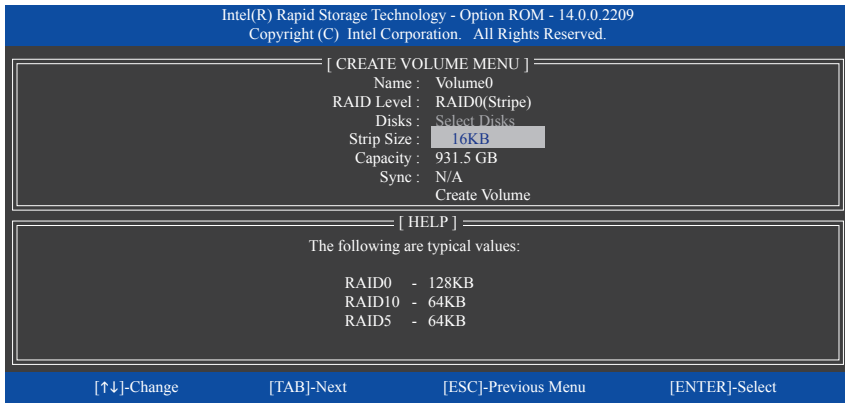

Figure 12

Step 5:

Enter the array capacity and press <Enter>. Finally press <Enter> on the **Create Volume** item to begin creating the RAID array. When prompted to confirm whether to create this volume, press <Y> to confirm or <N> to cancel (Figure 13).

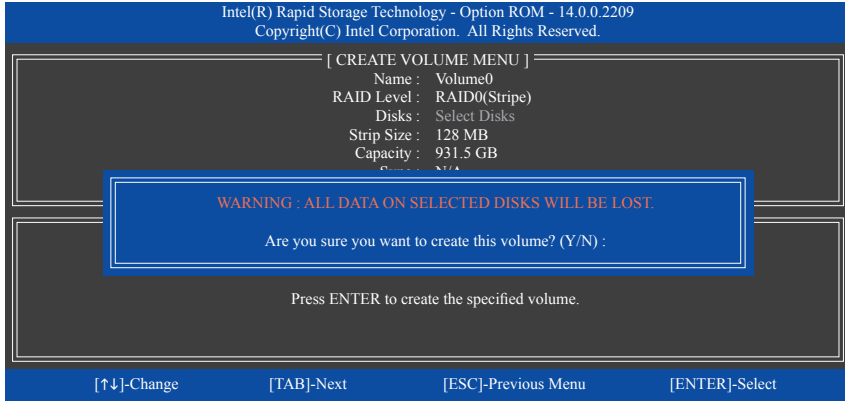

Figure 13

When completed, you can see detailed information about the RAID array in the **DISK/VOLUME INFORMATION** section, including the RAID level, stripe block size, array name, and array capacity, etc. (Figure 14)

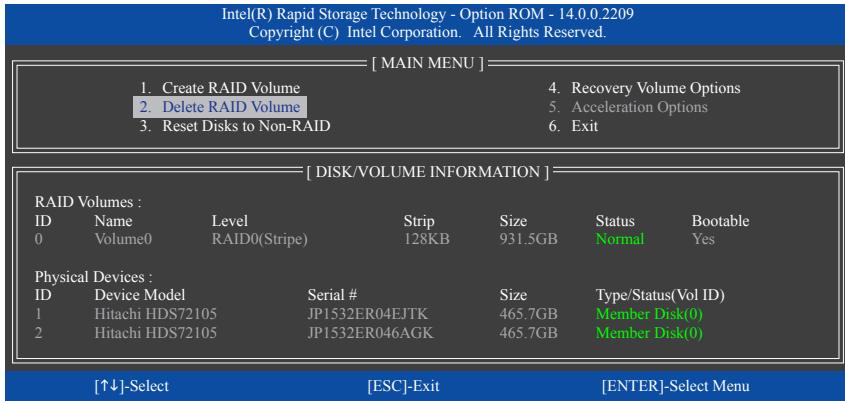

Figure 14

To exit the RAID BIOS utility, press <Esc> or select **6. Exit** in **MAIN MENU**.

Now, you can proceed to install the SATA RAID/AHCI driver and operating system.

Recovery Volume Options

Intel® Rapid Recover Technology provides data protection by allowing users to easily restore data and system operation using a designated recovery drive. With the Rapid Recovery Technology, which employs RAID 1 functionality, users can copy the data from the master drive to the recovery drive; if needed, the data on the recovery drive can be restored back to the master drive.

Before you begin:

- The recovery drive must have equal or greater capacity than the master drive.
- A recovery volume can be created with two hard drives only. A recovery volume and a RAID array cannot co-exist in the system at the same time, that is, if you have already created a recovery volume, you are unable to create a RAID array.
- By default, only the master drive can be viewed in the operating system; the recovery drive is hidden.

Step 1:

Select **Create RAID Volume** in **MAIN MENU** and press <Enter> (Figure 15).

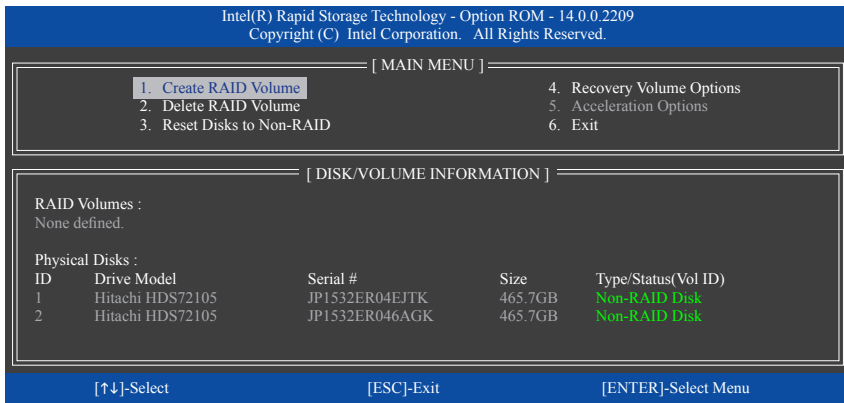

Figure 15

Step 2:

After entering the volume name, select **Recovery** under the **RAID Level** item and press <Enter> (Figure 16).

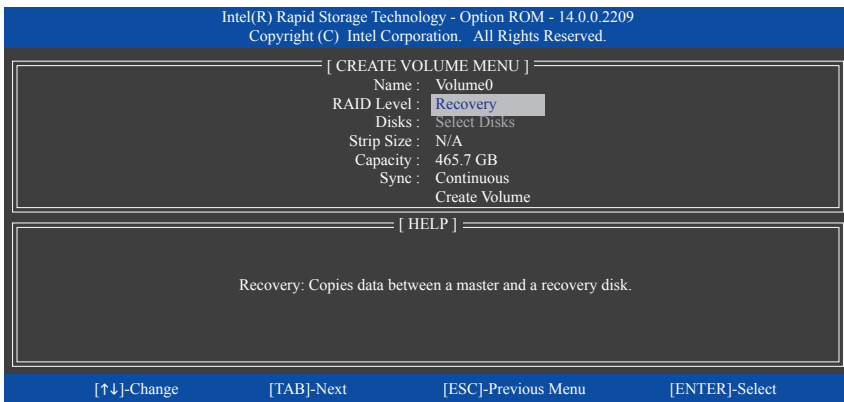

Figure 16

Step 3:

Press <Enter> under the **Select Disks** item. In the **SELECT DISKS** box, press <Tab> on the hard drive you want to use for the master drive and press <Space> on the hard drive you want to use for the recovery drive. (Make sure the recovery drive has equal or larger capacity than the master drive.) Then press <Enter> to confirm (Figure 17).

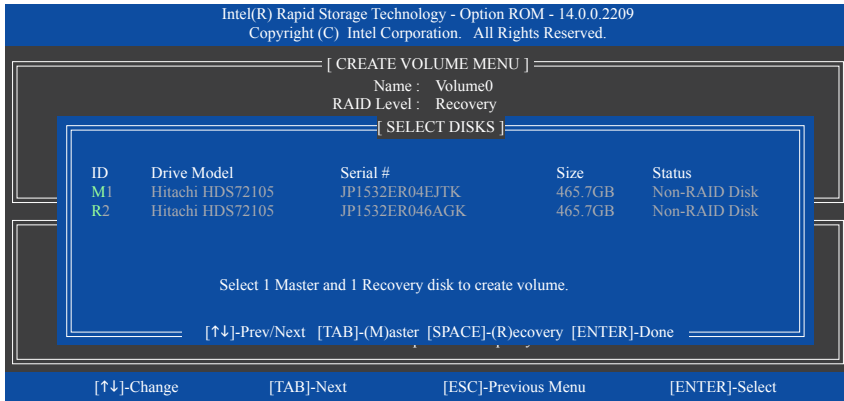

Figure 17

Step 4:

Under **Sync**, select **Continuous** or **On Request** (Figure 18). When set to **Continuous**, changes made to the data on the master drive will be automatically and continuously copied to the recovery drive when both hard drives are installed in the system. **On Request** allows users to update data from the master drive to the recovery drive manually using the Intel® Rapid Storage Technology utility in the operating system. **On Request** also allows users to restore the master drive to a previous state.

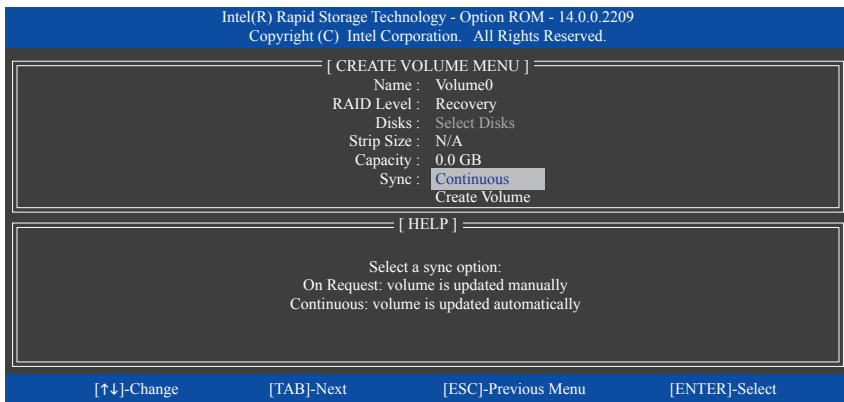

Figure 18

Step 5:

Finally press <Enter> on the **Create Volume** item to begin creating the Recovery Volume and follow the on-screen instructions to complete.

Delete RAID Volume

To delete a RAID array, select **Delete RAID Volume** in **MAIN MENU** and press <Enter>. In the **DELETE VOLUME MENU** section, use the up or down arrow key to select the array to be deleted and press <Delete>. When prompted to confirm your selection (Figure 19), press <Y> to confirm or <N> to abort.

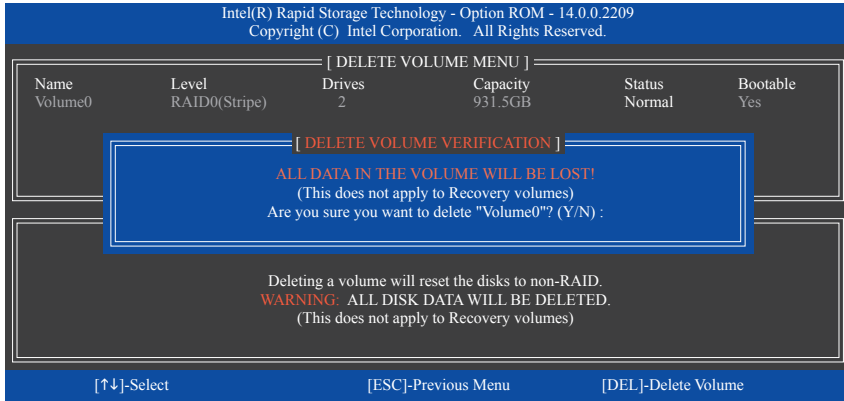

Figure 19

Acceleration Options

This option allows you to view the status of your accelerated drive/volume (Figure 20) created using the Intel® IRST utility. In case you are unable to run the Intel® IRST utility due to an application error or operating system issue, you will need to remove acceleration or manually enable synchronization (Maximized mode only) using this option in the RAID ROM utility.

Steps:

Select **Acceleration Options** in **MAIN MENU** and press <Enter>.

To remove the acceleration, select the accelerated drive/volume, press <R>, and press <Y> to confirm.

To synchronize data from the cache device to the accelerated drive/volume, press <S> and press <Y> to confirm.

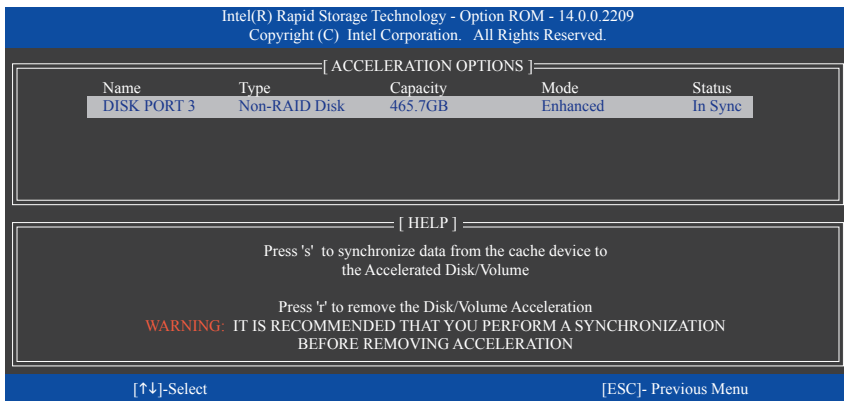

Figure 20

3-2 Installing the SATA RAID/AHCI Driver and Operating System

With the correct BIOS settings, you are ready to install the operating system.

A. Installing Windows

As some operating systems already include Intel® SATA RAID/AHCI driver, you do not need to install separate RAID/AHCI driver during the Windows installation process. After the operating system is installed, we recommend that you install all required drivers from the motherboard driver disk using "Xpress Install" to ensure system performance and compatibility. If the operating system to be installed requires that you provide additional SATA RAID/AHCI driver during the OS installation process, please refer to the steps below:

Step 1:

Copy the **IRST-x64** or **IRST-x86** folder (depending on your OS version) under the **Boot** folder in the driver disk to your USB thumb drive.

Step 2:

Boot from the Windows setup disk and perform standard OS installation steps. When the screen requesting you to load the driver appears, select **Browse**.

Step 3:

Insert the USB thumb drive and then browse to the folder (**IRST-x64** or **IRST-x86**) that you previously copied.

Step 4:

When a screen as shown in Figure 1 appears, select **Intel Chipset SATA RAID Controller** and click **Next** to load the driver and continue the OS installation.

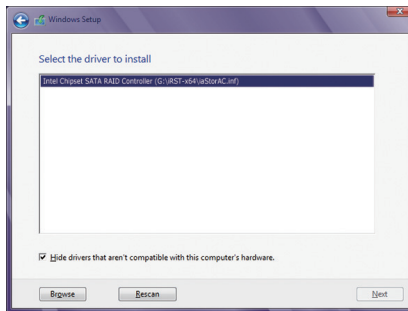

Figure 1

B. Rebuilding an Array

Rebuilding is the process of restoring data to a hard drive from other drives in the array. Rebuilding applies only to fault-tolerant arrays such as RAID 1, RAID 5 or RAID 10 arrays. The procedures below assume a new drive is added to replace a failed drive to rebuild a RAID 1 array. (Note: The new drive must have equal or greater capacity than the old one.)

Turn off your computer and replace the failed hard drive with a new one. Restart your computer.

- **Enabling Automatic Rebuild**

Step 1:

When the message "Press <Ctrl>-> to enter Configuration Utility" appears, press <Ctrl> + <I> to enter the RAID Configuration Utility. The following screen appears after you enter the RAID Configuration Utility.

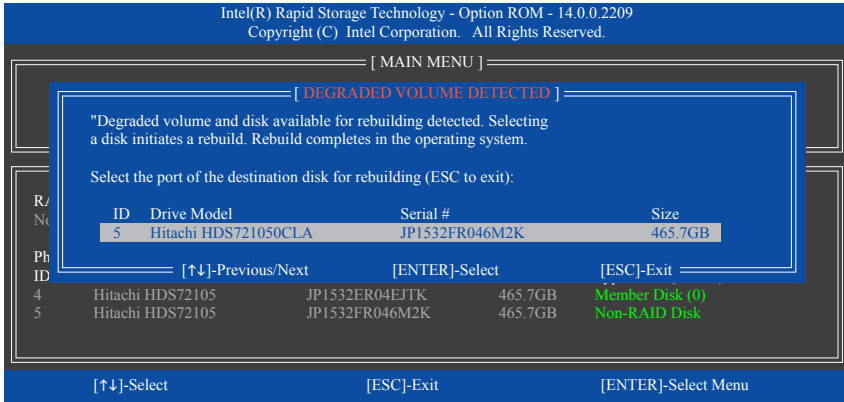

Step 2:

Select the new hard drive to add into the array to be rebuilt and press <Enter>. The following screen appears, indicating that an automatic rebuild will be performed after you enter the operating system. If you do not enable automatic rebuild on this stage, you have to manually rebuild the array in the operating system (see the next page for more details).

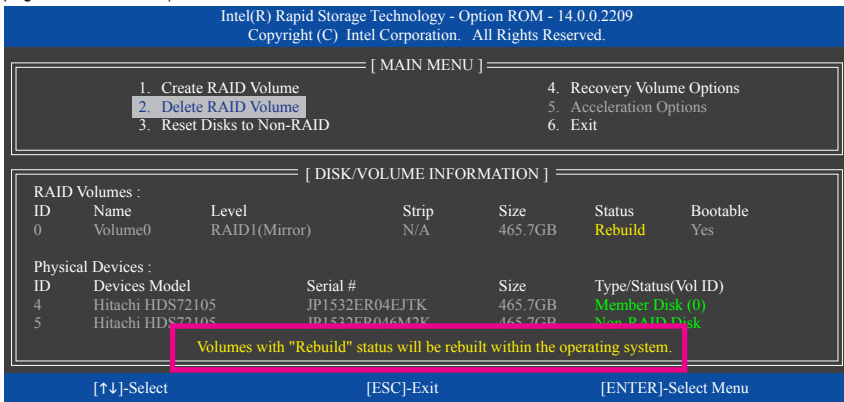

- **Performing the Rebuild in the Operating System**

While in the operating system, make sure the chipset driver has been installed from the motherboard driver disk. Then launch the Intel® Rapid Storage Technology utility from the desktop.

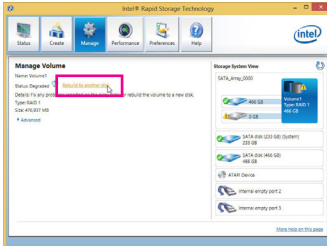

Step 1:

Go to the **Manage** menu and click **Rebuild to another disk** in **Manage Volume**.

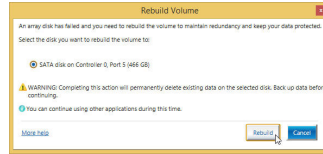

Step 2:

Select a new drive to rebuild the RAID and click **Rebuild**.

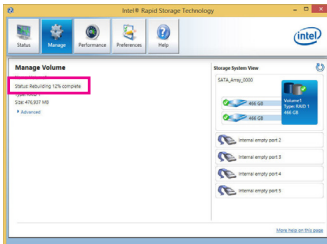

The **Status** item on the left of the screen displays the rebuild progress.

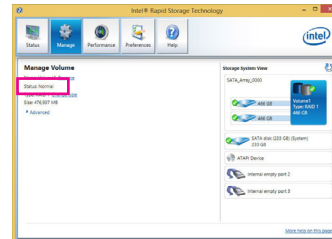

Step 3:

After the RAID 1 volume rebuilding, the **Status** will display as **Normal**.

- **Restoring the Master Drive to a Previous State (for Recovery Volume only)**

When two hard drives are set to Recovery Volume in Update on Request mode, you can restore the master drive data to the last backup state when needed. For example, in case the master drive detects a virus, you can restore the recovery drive data to the master drive.

Step 1:

Select **4. Recovery Volume Options** in the **MAIN MENU** of the Intel® RAID Configuration Utility. On the **RECOVERY VOLUMES OPTIONS** menu, select **Enable Only Recovery Disk** to show the recovery drive in the operating system. Follow the on-screen instructions to complete and exit the RAID Configuration Utility.

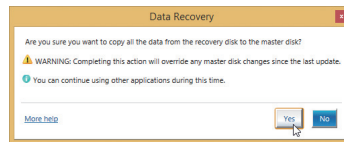
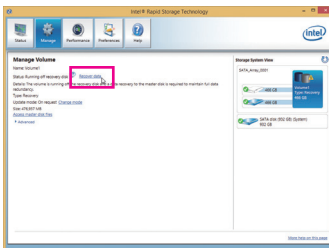
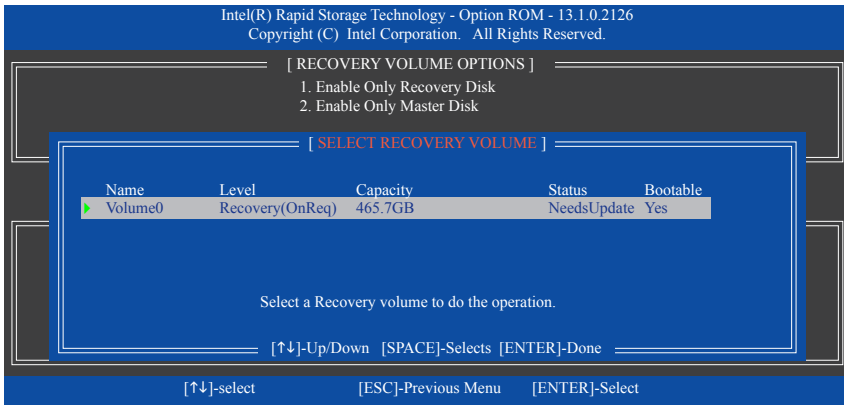

Step 3:
Click **Yes** to begin the data recovery.

Step 2:

Go to the **Manage** menu of the Intel® Rapid Storage Technology utility and click **Recover data** in **Manage Volume**.

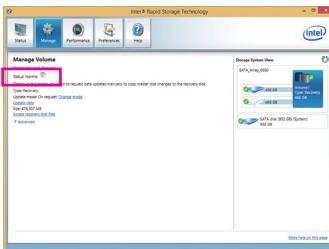
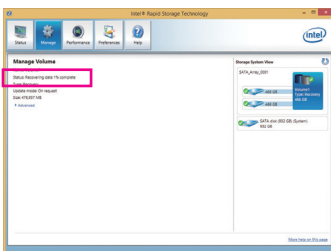

The **Status** item on the left of the screen displays the rebuild progress.

Step 4:
After the recovery volume is completed, the **Status** will display as **Normal**.

Chapter 4 Drivers Installation



- Before installing the drivers, first install the operating system. (The following instructions use Windows 8.1 as the example operating system.)
- After installing the operating system, insert the motherboard driver disk into your optical drive. Click on the message "Tap to choose what happens with this disc" on the top-right corner of the screen and select "Run Run.exe." (Or go to My Computer, double-click the optical drive and execute the Run.exe program.)

4-1 Drivers & Software

"Xpress Install" will automatically scan your system and then list all of the drivers that are recommended to install. You can click the **Xpress Install** button and "Xpress Install" will install all of the selected drivers. Or click the arrow  icon to individually install the drivers you need.

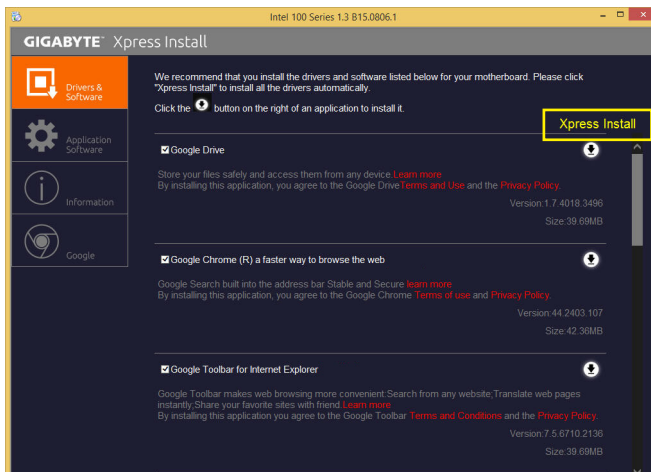

- Please ignore the popup dialog box(es) (e.g. the **Found New Hardware Wizard**) displayed when "Xpress Install" is installing the drivers. Failure to do so may affect the driver installation.
- Some device drivers will restart your system automatically during the driver installation. After the system restart, "Xpress Install" will continue to install other drivers.

4-2 Application Software

This page displays the apps that GIGABYTE develops and some free software. You can select the apps you want and click the **Install**  icon to begin the installation.

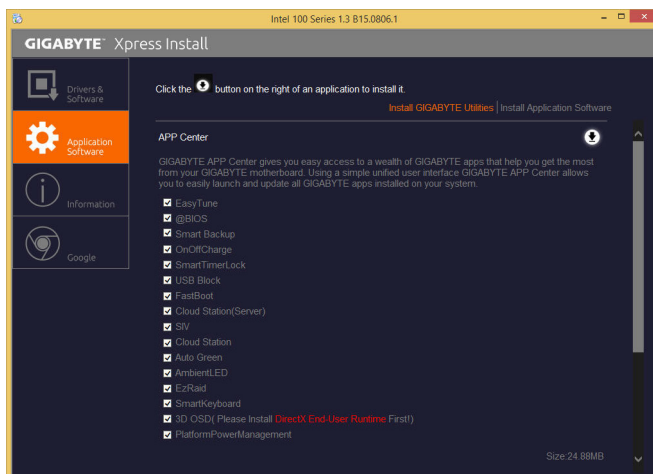

4-3 Information

This page provides detailed information on the drivers on the driver disk. The **Contact** page provides contact information of the GIGABYTE Taiwan headquarter. You can click the URL on this page to link to the GIGABYTE website to check more information on the GIGABYTE headquarter or worldwide branch offices.

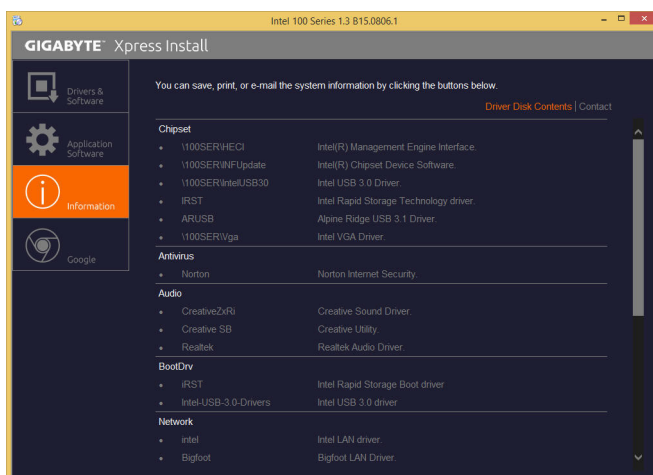

Chapter 5 Unique Features

5-1 BIOS Update Utilities

GIGABYTE motherboards provide two unique BIOS update tools, Q-Flash™ and @BIOS™. GIGABYTE Q-Flash and @BIOS are easy-to-use and allow you to update the BIOS without the need to enter MS-DOS mode. Additionally, this motherboard features the DualBIOS™ design and supports Q-Flash Plus, providing multiple protection for the safety and stability of your computer.

What is DualBIOS™?

Motherboards that support DualBIOS have two BIOS onboard, a main BIOS and a backup BIOS. Normally, the system works on the main BIOS. However, if the main BIOS is corrupted or damaged, the backup BIOS will take over on the next system boot and copy the BIOS file to the main BIOS to ensure normal system operation. For the sake of system safety, users cannot update the backup BIOS manually.

What is Q-Flash Plus?

Q-Flash Plus is a new solution derived from DualBIOS™. When both the main and backup BIOS fail during system boot, Q-Flash Plus will be automatically launched and then recover BIOS data from the USB flash drive connected to a specific USB port.

What is Q-Flash™?

With Q-Flash you can update the system BIOS without having to enter operating systems like MS-DOS or Window first. Embedded in the BIOS, the Q-Flash tool frees you from the hassles of going through complicated BIOS flashing process.

What is @BIOS™?

@BIOS allows you to update the system BIOS while in the Windows environment. @BIOS will download the latest BIOS file from the nearest @BIOS server site and update the BIOS.

5-1-1 Updating the BIOS with the Q-Flash Utility

A. Before You Begin

1. From GIGABYTE's website, download the latest compressed BIOS update file that matches your motherboard model.
2. Extract the file and save the new BIOS file (e.g. Z170XSOCForce.F1) to your USB flash drive, or hard drive. Note: The USB flash drive or hard drive must use FAT32/16/12 file system.
3. Restart the system. During the POST, press the <End> key to enter Q-Flash. Note: You can access Q-Flash by either pressing the <End> key during the POST or pressing the <F8> key in BIOS Setup. However, if the BIOS update file is saved to a hard drive in RAID/AHCI mode or a hard drive attached to an independent SATA controller, use the <End> key during the POST to access Q-Flash.



Because BIOS flashing is potentially risky, please do it with caution. Inadequate BIOS flashing may result in system malfunction.

B. Updating the BIOS

In the main menu of Q-Flash, use the keyboard or mouse to select an item to execute. When updating the BIOS, choose the location where the BIOS file is saved. The following procedure assumes that you save the BIOS file to a USB flash drive.

Step 1:

1. Insert the USB flash drive containing the BIOS file into the computer. In the main menu of Q-Flash, select **Update BIOS From Drive**.



- The **Save BIOS to Drive** option allows you to save the current BIOS file.
- Q-Flash only supports USB flash drive or hard drives using FAT32/16/12 file system.
- If the BIOS update file is saved to a hard drive in RAID/AHCI mode or a hard drive attached to an independent SATA controller, use the <End> key during the POST to access Q-Flash.

2. Select **USB Flash Drive**.

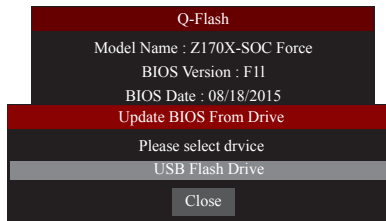

3. Select the BIOS update file.



Make sure the BIOS update file matches your motherboard model.

Step 2:

The screen will show that the BIOS file is being read from your USB flash drive. Please select **Quick Update** or **Normal Update** to begin the BIOS update. The screen will then display the update process.



- **Do not turn off or restart the system when the system is reading/updating the BIOS.**
- **Do not remove the USB flash drive or hard drive when the system is updating the BIOS.**

Step 3:

The system will restart after the update process is complete.

Step 4:

During the POST, press <Delete> to enter BIOS Setup. Select **Load Optimized Defaults** on the **Save & Exit** screen and press <Enter> to load BIOS defaults. System will re-detect all peripheral devices after a BIOS update, so we recommend that you reload BIOS defaults.

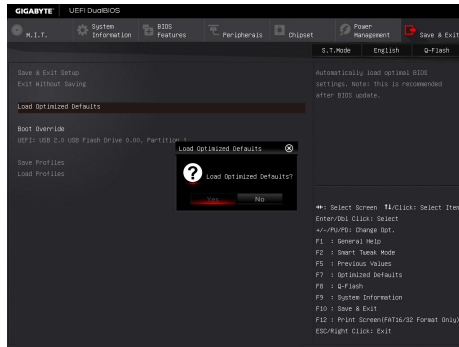

Select **Yes** to load BIOS defaults

Step 5:

Select **Save & Exit Setup** and press <Enter>. And then select **Yes** to save settings to CMOS and exit BIOS Setup. The procedure is complete after the system restarts.

5-1-2 Updating the BIOS with the @BIOS Utility

A. Before You Begin

1. In Windows, close all applications and TSR (Terminate and Stay Resident) programs. This helps prevent unexpected failures when performing a BIOS update.
2. If the BIOS is being updated via the Internet, ensure the Internet connection is stable and do NOT interrupt the Internet connection (for example, avoid a power loss or switching off the Internet). Failure to do so may result in a corrupted BIOS or a system that is unable to start.
3. GIGABYTE product warranty does not cover any BIOS damage or system failure resulting from an inadequate BIOS flashing.

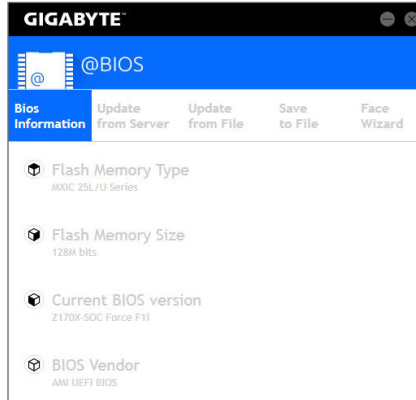

B. Using @BIOS

1. Update the BIOS Using the Internet Update Function:



Click **Update from Server**, select the @BIOS server site closest to your location and then download the BIOS file that matches your motherboard model. Follow the on-screen instructions to complete.



If the BIOS update file for your motherboard is not present on the @BIOS server site, please manually download the BIOS update file from GIGABYTE's website and follow the instructions in "Update the BIOS without Using the Internet Update Function" below.

2. Update the BIOS without Using the Internet Update Function:



Click **Update from File**, then select the location where you save the BIOS update file obtained from the Internet or through other source. Follow the on-screen instructions to complete.

3. Save the Current BIOS File:



Click **Save to File** to save the current BIOS file.

4. Change the Boot-up Logo:



Click **Upload new image** in Face-Wizard and you will be able to change the boot-up logo with your own picture, creating a personalized boot-up screen. Click **Backup current image** to save the current boot-up logo.



Supported image formats include jpg, bmp, and gif.

C. After Updating the BIOS

Restart your system after updating the BIOS.



- Make sure that the BIOS file to be flashed matches your motherboard model. Updating the BIOS with an incorrect BIOS file could cause your system not to boot.
- Do not turn off the system or remove the power during the BIOS update process, or the BIOS may corrupt and the system may not boot.

5-1-3 Using Q-Flash Plus

A. Before You Begin

1. From GIGABYTE's website, download the latest compressed BIOS update file that matches your motherboard model.
2. Uncompress the downloaded BIOS file, save it to your USB flash drive, and rename it to **GIGABYTE.bin**.
Note: The USB flash drive must use the FAT32/16 file system and it must be a USB 2.0 flash drive.
3. Insert the USB flash drive into the white USB port on the back panel.

B. Using Q-Flash Plus

If both the main and backup BIOS fail during system boot, wait for 15-20 seconds, the system will automatically search and match the BIOS file in the USB flash drive on the white USB port. The F_BIOS_LED will flash when the BIOS matching and flashing activities start.

Wait for 2-3 minutes and the F_BIOS_LED will stop flashing when the main BIOS flashing is complete.



After the main BIOS is flashed, the system will reboot automatically and then DualBIOS™ will continue to update the backup BIOS. After completion, the system will reboot again and boot from the main BIOS for normal operation.

5-1-4 Using GIGABYTE HW OC

GIGABYTE HW OC allows you to use your smart phone/tablet device to overclock or monitor your computer.

A. Before You Begin

1. Install GIGABYTE HW OC on your smart phone/tablet device. (For Android systems, please download the app from Google Play; for iOS systems, please download it from App Store.)
2. Your smart phone/tablet device must have Android 4.0/iOS 7.1 or above version.
3. Connect one end of your USB charging cable to the white USB port on the motherboard back panel and the other end to your smart phone/tablet device.
4. Press the OCPSW button on the motherboard back panel.

B. Using GIGABYTE HW OC

B-1 For Android Platforms

1. After your computer is powered on, open the GIGABYTE HW OC app on your smart phone/tablet device.
2. A message will appear, prompting you to turn on USB tethering for your device first. After enabling USB tethering, re-open GIGABYTE HW OC.
3. Wait for a few seconds and the FBIO_LED (next to the white USB port) on the motherboard back panel will lit up, indicating a successful connection between your smart phone/tablet device and your computer. Then you can adjust the overclock/overvoltage options on the **Advanced CPU OC** menu or check the hardware monitoring items on the **Hardware Monitor** menu.

B-2 For iOS Platforms

1. After your computer is powered on, enable Personal Hotspot on your smart phone/tablet device (go to Settings > Personal Hotspot). Make sure to select USB Only.
2. After Personal Hotspot is enabled, you should now see a bar at the top of your screen that reads "Personal Hotspot: 1 Connection." And the FBIO_LED (next to the white USB port) on the motherboard back panel will lit up, indicating a successful connection between your smart phone/tablet device and your computer.
3. Next, tap on the GIGABYTE HW OC app on your smart phone/tablet device to open it. After a few seconds, you can adjust the overclock/overvoltage options on the **Advanced CPU OC** menu or check the hardware monitoring items on the **Hardware Monitor** menu.

5-2 APP Center

GIGABYTE App Center gives you easy access to a wealth of GIGABYTE apps that help you get the most from your GIGABYTE motherboard (Note). Using a simple, unified user interface, GIGABYTE App Center allows you to easily launch all GIGABYTE apps installed on your system, check related updates online, and download the apps, drivers, and BIOS.

Running the APP Center

Insert the motherboard driver disk. On the Autorun screen, go to **Application Software** Install GIGABYTE Utilities to install GIGABYTE App Center and the selected apps. Restart your computer after the installation is complete. In Desktop mode, click the App Center icon  in the notification area to launch the App Center utility (Figure 1). On the main menu, you can select an app to run or click **LiveUpdate** to update an app online.

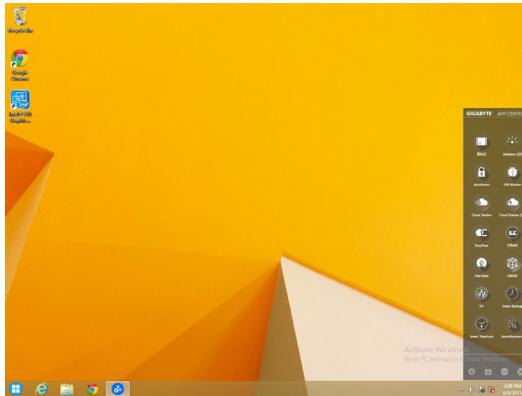

Figure 1

If the App Center is closed, you can restart it by clicking the Launch App Center icon on the Apps menu (Figure 2).

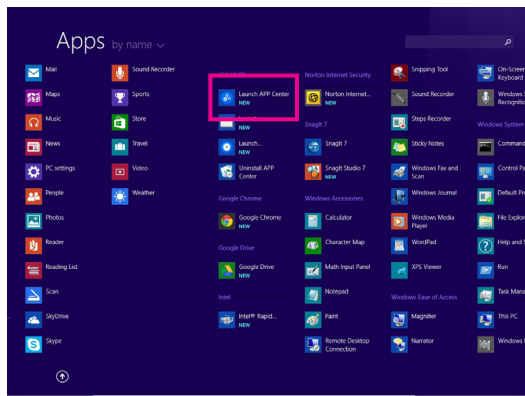

Figure 2

(Note) Available applications in APP Center may differ by motherboard model. Supported functions of each application may also vary depending on motherboard specifications.

5-2-1 EasyTune

GIGABYTE's EasyTune is a simple and easy-to-use interface that allows users to fine-tune their system settings or do overclock/overvoltage in Windows environment.

The EasyTune Interface

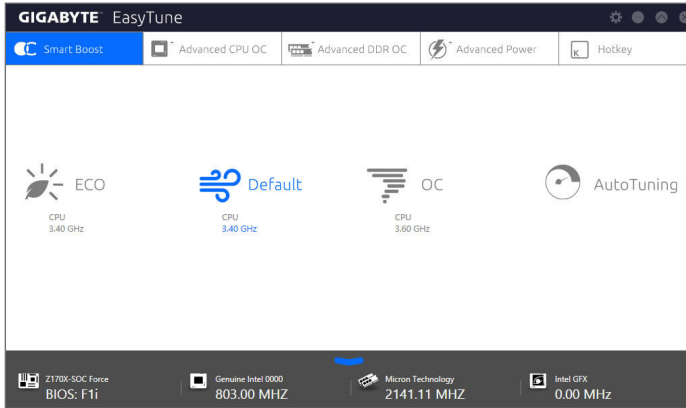

Tabs Information

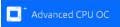
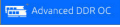
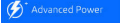
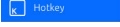
Tab	Description
 Smart Boost	The Smart Boost tab provides you with different levels of CPU frequency to choose to achieve desired system performance. After making changes, be sure to restart your system for these changes to take effect.
 Advanced CPU OC	The Advanced CPU OC tab allows you to set CPU base clock, frequency, and voltages, and integrated graphics frequency. You can save the current settings to a profile. You can create up to 2 profiles.
 Advanced DDR OC	The Advanced DDR OC tab allows you to set the memory clock.
 Advanced Power	The Advanced Power tab allows you to adjust voltages.
 Hotkey	The HotKey tab allows you to set hotkeys for your profiles.



Available functions in EasyTune may vary by motherboard model and CPU. Grayed-out area(s) indicates that the item is not configurable or the function is not supported.



Incorrectly doing overclock/overvoltage may result in damage to the hardware components such as CPU, chipset, and memory and reduce the useful life of these components. Before you do the overclock/overvoltage, make sure that you fully know each function of EasyTune, or system instability or other unexpected results may occur.



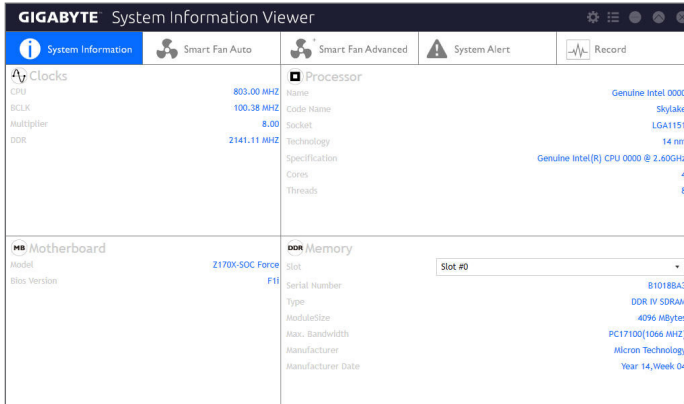

5-2-2 System Information Viewer

GIGABYTE System Information Viewer allows you to monitor and adjust the fan speed in the operating system. You can also display the hardware monitor information on the desktop to view the system status at any time.

The System Information Viewer Interface

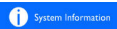
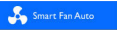

Tabs Information

Tab	Description
 System Information	The System Information tab provides information on the installed CPU, motherboard, and the BIOS version.
 Smart Fan Auto	The Smart Fan Auto tab allows you to specify a Smart Fan mode.
 Smart Fan Advanced	The Smart Fan Advance tab allows you to adjust the smart fan speed. The fans will run at different speeds according to system temperatures. Using the Smart Fan option you can adjust the fan's workload according system temperatures or you can fix the fan speeds using the RPM Fixed Mode option. Click the Calibrate button and the fan speed will be shown in relation to overall fan workload after calibration. The Reset button can revert the fan settings back to the last saved values.
 System Alert	The System Alerts tab allows you to monitor hardware temperature, voltage and fan speed, and set temperature/fan speed alarm.
 Record	The Record tab allows you to record changes in system voltages, temperatures, and fan speeds. Please note, the recording will stop if you exit the Record tab during the recording process.



The speed control function requires the use of a fan with fan speed control design.

5-2-3 Fast Boot

Through the simple GIGABYTE Fast Boot^(Note 1) interface, you can enable or change the Fast Boot or Next Boot After AC Power Loss setting right in the operating system.

The Fast Boot Interface

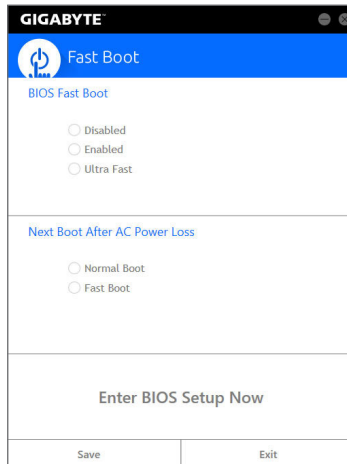

Using Fast Boot

- **BIOS Fast Boot:**

This option is the same as the **Fast Boot** option^(Note 2) in BIOS Setup. It allows you to enable or disable the fast boot function to shorten OS boot time.

- **Next Boot After AC Power Loss:**

This option is the same as the **Next Boot After AC Power Loss** option^(Note 2) in BIOS Setup. It allows you to select the system bootup mode upon the return of an AC power loss. (This mode is configurable only when **BIOS Fast Boot** is set to **Enabled** or **Ultra Fast**.)

After you configure the setting, click **Save** to save and click **Exit**. The settings will take effect on next boot. If you click the **Enter BIOS Setup Now** button, the system will restart and enter BIOS Setup immediately.

(Note 1) This function is supported by Windows 10/8.1 only.

(Note 2) For more details about this function, refer to Chapter 2, "BIOS Features."

5-2-4 Smart TimeLock

GIGABYTE Smart TimeLock allows you to effectively manage computer or Internet usage time with simple rules and options.

The Smart TimeLock Interface

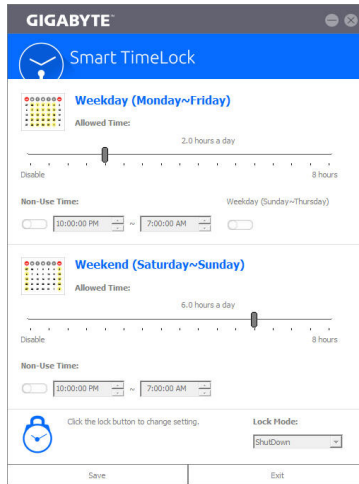

Using Smart TimeLock

Click the lock icon  on the bottom left corner and enter the password ^(Note). Set the time when a user can or cannot use your computer for weekdays and weekends. The **Lock Mode** on the bottom right corner allows you to choose to turn off the computer or only close the Internet connection during the specified time period. Click **Save** to save the settings and click **Exit** to exit.

An alert will appear 15 minutes and 1 minute prior to the default shutdown time. When the alert appears, you can enter the password to extend the usage time or click **Cancel** to close the alert. If you respond **Cancel**, you will be requested to enter the password to extend the usage time again when the default shutdown time arrives, or the computer will shutdown right away.

(Note) You can set the User Password in the system BIOS Setup program to prevent the system time being changed by other users.

5-2-5 USB Blocker

GIGABYTE USB Blocker provides you with an easy-to-use interface that allows you to block certain USB device types on your PC. Devices classes that are blocked will be ignored by the operating system.

The USB Blocker Interface

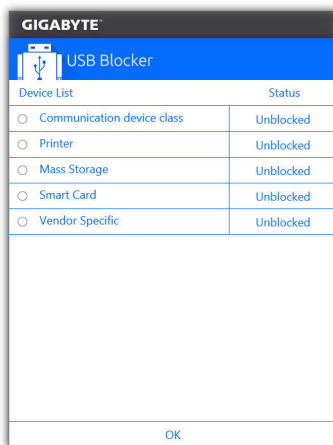

Using USB Blocker

Select the class of USB device that you would like to block or unblock. Double left-click to change the **Blocked** or **Unblocked** status and click **OK**. Then enter your password and click **OK** to complete.

5-2-6 Smart Keyboard

GIGABYTE Smart Keyboard allows you to define your own commands/hotkeys, change the mouse sensitivity, and create shortcut and password to open a web page or document file, helping you make the most out of your keyboard and mouse.

The Smart Keyboard Interface

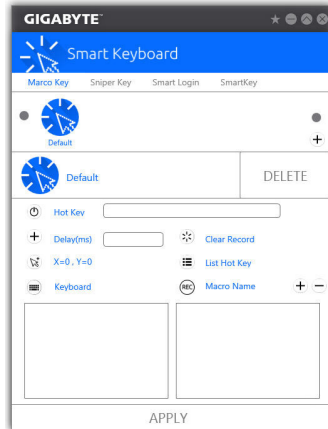

Using Smart Keyboard:

- **Marco Key:**
Create macro commands and define your own hotkeys to quickly perform the function you want.
- **Sniper Key:**
Using the Sniper key you can switch the mouse sensitivity when you are in sniper mode for better sniper accuracy.
- **Smart Login:**
Create shortcut and password to open a web page or document file.
- **Smart Key:**
Enable or disable hotkeys for activating overclocking and power-saving features.

(Note) It is recommended that Smart Keyboard be closed if it violates the end user license agreement of your game.

5-2-7 Smart Backup

Smart Backup allows you to back up a partition as an image file every hour. You can use these images to restore your system or files when needed.

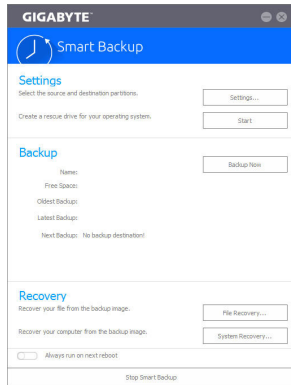

The Smart Backup main menu:

Button	Description
Settings	Allows you to select the source and destination partition
Start	Allows you to create a rescue drive
Backup Now	Allows you to perform the backup immediately
File Recovery...	Allows you to recover your files from the backup image
System Recovery...	Allows you to recover your system from the backup image



- Smart Backup only supports NTFS file system.
- You need to select the destination partition in **Settings** the first time you use Smart Backup.
- The **Backup Now** button will be available only after 10 minutes you have logged in Windows.
- Select the **Always run on next reboot** checkbox to automatically enable Smart Backup after system reboot.

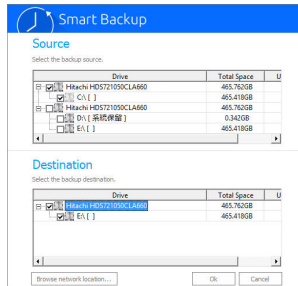

Creating a backup:

Click the **Settings** button on the main menu. In the **Settings** dialog box, select the source partition and destination partition and click **OK**. The initial backup will start after 10 minutes and regular backup will be performed hourly. Note: By default, all partitions on the system drive are selected as the backup source. The backup destination cannot be on the same partition as the backup source.

Saving the backup to a network location:

If you want to save the backup to a network location, select **Browse network location**. Make sure your computer and the computer where you want to save the backup are in the same domain. Choose the network location where you want to store the backup and enter the user name and password. Follow the on-screen instructions to complete.

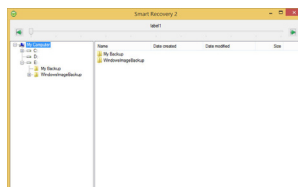

Recovering a file:

Click the **File Recovery** button on the main menu. Use the time slider on the top of the popped out window to select a previous backup time. The right pane will display the backed-up partitions in the backup destination (in the **My Backup** folder). Browse to the file you want and copy it.

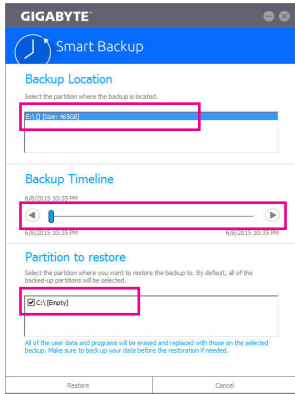

Recovering your system with Smart Backup:

Steps:

1. Click the **System Recovery** button on the main menu.
2. Select the location where your backup is saved.
3. Use the time slider to select a time point.
4. Select a partition backup created on the selected time point and click **Restore**.
5. Confirm whether to restart your system to proceed with the restore immediately or later. Once you respond "Yes" the system will restart to the Windows recovery environment. Follow the onscreen instructions to restore your system.



All of your files and programs will be deleted and replaced with those on the selected backup. If needed, be sure to make a copy of your data before the restore.

5-2-8 Ambient LED

GIGABYTE Ambient LED allows you to enable or change the display mode for the onboard audio LEDs and rear panel I/O shield^(Note) LEDs while in the Windows environment.

The Ambient LED Interface

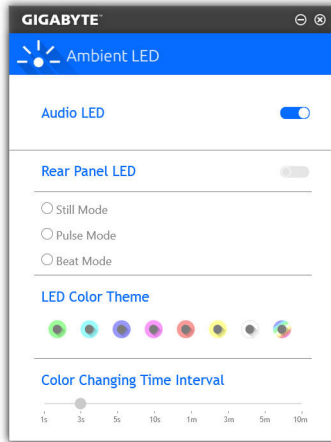

Using Ambient LED

- **Audio LED:**
Allows you to enable or disable the onboard audio LEDs.
- **Rear panel LED^(Note):**
Allows to you enable or disable the rear panel LEDs and specify the LED behavior.

Still Mode -- LEDs are constantly lit.
Beat Mode -- LEDs will blink according to the rhythm of the music played on your system.
Pulse Mode -- LEDs will blink slowly and smoothly like breath.
- **LED Color Theme:**
Allows to you specify the display color of the LEDs.
- **LED Changing Time Interval:**
Allows you to specify the color-changing interval if you select the color loop option.

(Note) This function only works for motherboards with an I/O shield that has audio LEDs.

5-2-9 3D OSD

3S OSD ^(Note) automatically detects and displays your system information during games, allowing you to easily get hold of your system information without switching between screens.

The 3D OSD Interface

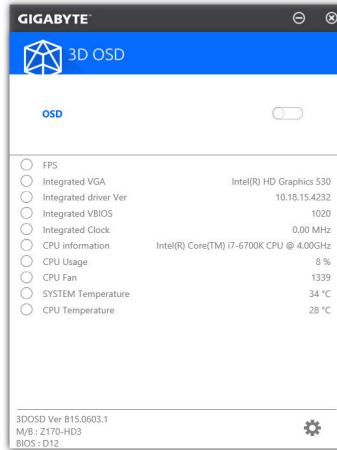

Using 3D OSD

Main Menu:

Allows you to enable or disable the 3D OSD feature and to select the type of real-time system information you wish to display. 3D OSD will detect and display a list of available options.

Configuration Menu:

Allows you to set a hotkey for enabling /disabling 3D OSD and specify the font size/location/color of the displayed information.

(Note) Please ensure that DirectX End-User Runtime has been installed on your system prior to installing 3D OSD.

5-2-10 Cloud Station

GIGABYTE Cloud Station (Server) is composed of HomeCloud, GIGABYTE Remote, Remote OC, and HotSpot, which allow your smart phone, tablet device, and remote computer to communicate, share resources, and control the host computer via wireless connection. Cloud Station allows your computer to share files with another computer that has Cloud Station (Server) installed.

Before You Begin:

- To use HomeCloud, GIGABYTE Remote, and Remote OC, you must install GIGABYTE Cloud Station on your smart phone/tablet device. (For Android systems, please download the app from Google Play; for iOS systems, please download it from App Store.)^(Note 1)
- To share HomeCloud files between computers, you need to install Cloud Station (Server) on the host computer and Cloud Station on the remote computer.
- Your smart phone/tablet device must have Android 4.0/iOS 6.0 or above version.
- The first time you use HomeCloud, GIGABYTE Remote, and Remote OC, you must sign in with your Google/Facebook/Windows Live account. Be sure to use the same account to sign in on your smart phone/tablet device and computers.

HomeCloud

HomeCloud allows you to upload/download/back up files ^(Note 2) from your smart phone/tablet device/computer to the host computer.

The HomeCloud Interface

Cloud Station (Server):

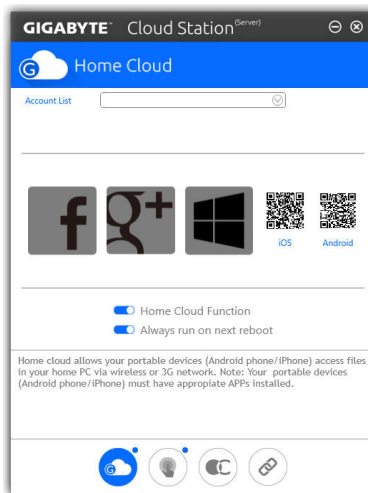

(Note 1) You can use your smart phone/tablet device to scan the QR code on the HomeCloud UI to link to the download page of the GIGABYTE Cloud Station on App Store or Google Play.

(Note 2) For iOS systems, the file types are limited to image/video files.

Cloud Station:

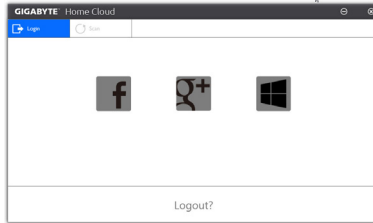

Using HomeCloud

Step 1:

Launch HomeCloud on the host computer (installed with Cloud Station (Server)), sign in with your Google/Facebook/Windows Live account or select the account on the **Account List**. Then enable **HomeCloud Function**. To automatically enable this function after system reboot, enable **Always run on next reboot**.

Step 2:

Run Cloud Station on your smart phone/tablet device/remote computer, sign in with the same account you use for HomeCloud on your host computer. Tap on **HomeCloud** to perform the following functions:

On the Host Computer:

Option	Function
Account List	Displays currently signed in account(s).
Remove	Remove the selected account.
Share Folder	Displays the shared folder directory of the currently signed in account.
Open Folder	Access the shared folder of the currently signed in account.

On the Smart Phone/Tablet Device/Remote Computer:

Option	Function
All Picture Files	File Upload: Tap on the folder, browse and select the files inside. Tap on the menu icon and select Upload selected Files to upload the files to your computer. File Download: Tap on the folder and then tap on the menu icon, select Download Files . You can browse the files and select the files that you want to download to your smart phone/tablet device.
All Music Files	
All Video Files	
All Files	
User Contacts	Tap on the folder and then tap on the menu icon to use the options including Backup to remote, Restore From remote, View Remote Contact, and Reselect Computers .
Call Log	

GIGABYTE Remote

GIGABYTE Remote allows you to use your smart phone/tablet device to remotely control the mouse/keyboard/Windows Media Player on your computer.

The GIGABYTE Remote Interface

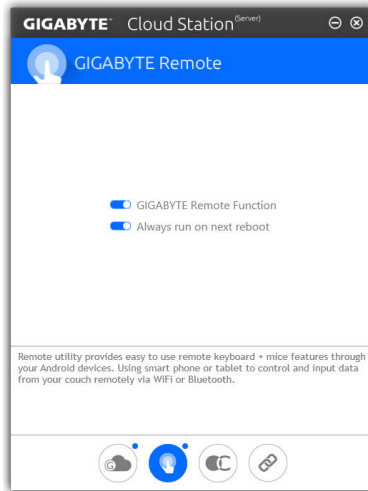

Using GIGABYTE Remote

Step 1:

On the host computer, launch GIGABYTE Remote and enable **GIGABYTE Remote Function**. To automatically enable this function after system reboot, enable **Always run on next reboot**.

Step 2:

Run GIGABYTE Cloud Station on your smart phone/tablet device, sign in with the same account you use for HomeCloud on your computer. Tap on **Remote Control** to perform the following remote controls:

On the Smart Phone/Tablet Device:

Option	Function
Mouse	Remotely perform mouse functionalities including dragging, right/left-clicking, and holding the mouse left button.
Keyboard	Remotely control your keyboard such as text input (tap on Real-Time Mode to type texts) or deletion.
Media	Remotely configure and control the currently running Windows Media Player application on your computer.

Remote OC

Remote OC provides you with remote control options including overclocking and system tweaking, system monitoring plus the ability to also remotely power down/reset the PC when needed.

The Remote OC Interface

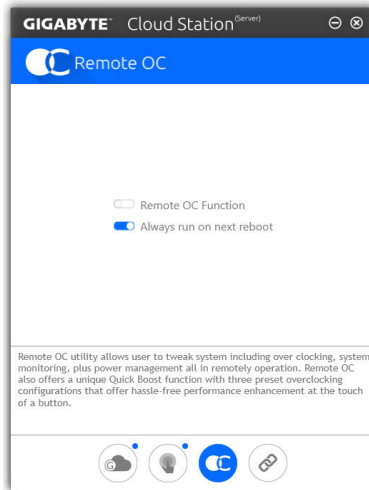

Using Remote OC

Step 1:

On the host computer, launch Remote OC and enable **Remote OC Function**. To automatically enable this function after system reboot, enable **Always run on next reboot**.

Step 2:

Run GIGABYTE Cloud Station on your smart phone/tablet device, sign in with the same account you use for HomeCloud on your computer. Tap on **Remote OC** to perform the following functions:

On the Smart Phone/Tablet Device:

Option	Function
Tuner	Allows you to change CPU/memory frequency and voltage settings.
INFO	Displays the system information, including the CPU, motherboard, and memory.
HW MONIT	Allows you to monitor system temperatures, voltages, and fan speeds.
QUICK BOOST	Provides you with three preset overclocking configurations.
CONTROL	Allows you to remotely reboot or shut down your computer.

HotSpot

HotSpot turns your computer into a virtual wireless access point and allows you to share your connection with your other wireless devices. Make sure your computer has been connected to a network and Wi-Fi is enabled.

The HotSpot Interface

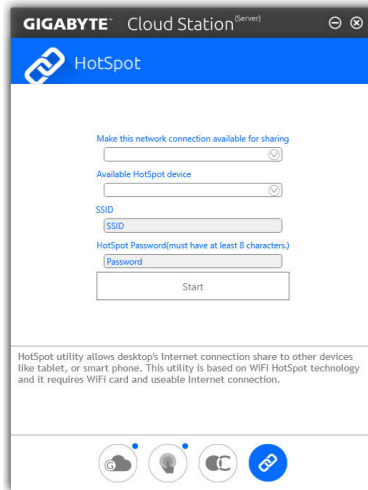

Using HotSpot:

Configuring your host computer:

The options are as follows. Make sure to click **Start** to complete.

- **Make this network connection available for sharing:**
Select a currently running network connection you want to share.
- **Available HotSpot device:**
Select a network virtual adapter. If there are more than one Wi-Fi card on your computer, you need to select the one you want to use from the list.
- **SSID:**
The hotspot SSID name. You can keep the default name or create your own one.
- **HotSpot Password(must have at least 8 characters):**
The password is required when other wireless devices want to access the Internet through the virtual wireless access point. You can keep the default name or create your own one. The password must have at least 8 characters and cannot be empty.

Sharing your connection with other wireless devices:

First make sure Wi-Fi is enabled on the wireless devices. Then browse to the network configuration screen, search for available Wi-Fi networks, and tap the name of your virtual wireless access point, enter the password, and confirm.

5-2-11 AutoGreen

AutoGreen^(Note) is an easy-to-use tool that provides users with simple options to enable system power savings via a Bluetooth-enabled smart phone/tablet device. When the device is out of the range of the computer's Bluetooth receiver, the system will enter the specified power saving mode. Before using this app, you need to turn on Bluetooth on both your computer and smart phone/tablet device.

The AutoGreen Interface

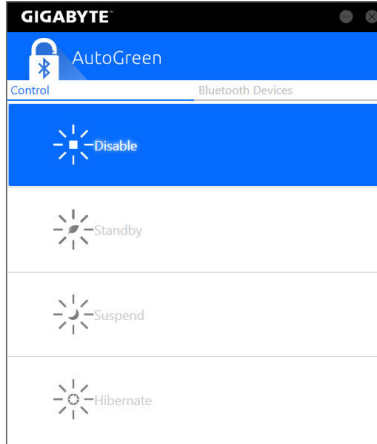

Control Tab:

The **Control** tab allows you to select a system power saving mode.

Button	Description
Disable	Disables this function
Standby	Enters Power on Suspend mode
Suspend	Enters Suspend to RAM mode
Hibernate	Enters Suspend to Disk mode

Bluetooth Devices Tab:

The **Bluetooth** tab allows you to pair your smart phone/tablet device with the Bluetooth receiver on your computer. Press **Refresh** to let AutoGreen search for the Bluetooth devices around you. A message will appear on both your computer and smart phone/tablet device prompting you to compare the passcodes on the two devices. Confirm to complete the pairing process.

(Note) Once your smart phone/tablet device has been paired with your AutoGreen-enabled computer, you'll not be able to use it to connect to other Bluetooth device(s).

5-2-12 Easy RAID

The GIGABYTE Easy RAID utility includes the following 'EZ' setups applications that will offer greatly simplified install and configuration procedures: Disk Mode Switch, EZ Smart Response, and XHD.

Disk Mode Switch

Disk Mode Switch allows you to change the SATA controller disk mode from AHCI to RAID mode even after the hard drive has been installed with an operating system. After switching the operating mode, please restart your computer and make sure the Intel® Rapid Storage Technology utility can work properly.

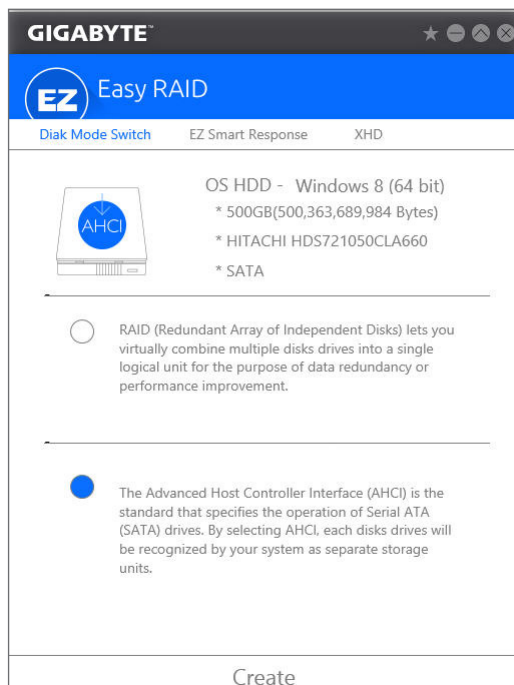

EZ Smart Response

A. System Requirements

1. An Intel® Chipset-based motherboard supporting this feature
2. Intel® Core series processor
3. Intel® SATA controllers set to RAID mode
4. Intel® Rapid Storage Technology utility installed ^(Note 1)
5. A conventional SATA disk and an SSD ^(Note 2)
6. Windows 7 with SP1/Windows 8.1/Windows 10 ^(Note 3)



If you have installed the operating system before configuring the Smart Response Technology, all original data on the SSD will be lost once you enable RAID mode ^(Note 4). It is recommended that you back up the hard disk before enabling the Smart Response Technology.

B. Using EZ Smart Response

Select **EZ Smart Response** and click **Create**.

To disable this function, click **Delete**.

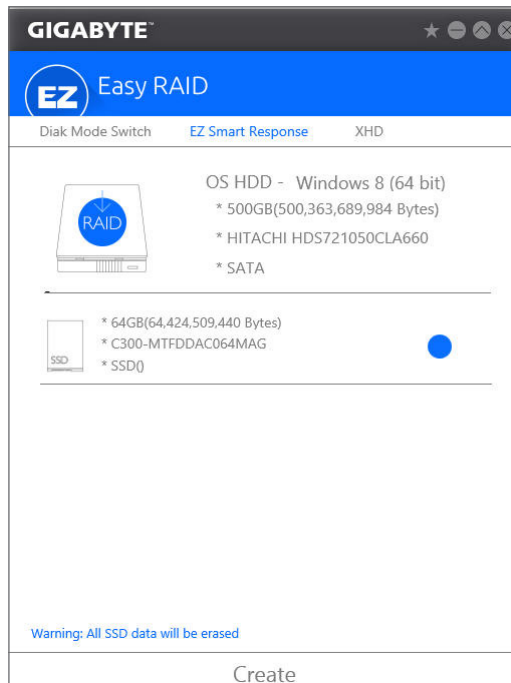

(Note 1) Before start, make sure you have installed the Intel® Rapid Storage Technology utility (version 14.5 or above).

(Note 2) The SSD works as a cache of the hard disk. The maximum cache memory size is 64 GB. If you use an SSD larger than 64 GB, the space beyond 64 GB can still be used for storing your data.

(Note 3) The operating system must be installed to the SATA disk.

(Note 4) If the SATA controllers are set to AHCI mode in BIOS Setup, they will be forced to RAID mode.

XHD

With GIGABYTE XHD ^(Note 1), users can quickly configure a RAID-ready system for RAID 0 when a new SATA drive is added. All with a simple click of a button, XHD helps to enhance your hard drive read/write performance without the need for complex and time-consuming configurations.

A. System Requirements

1. An Intel® Chipset motherboard supporting RAID
2. Intel® SATA controllers set to RAID mode
3. Intel® Rapid Storage Technology utility installed
4. Windows 7 with SP1/Windows 8.1/Windows 10
5. Intel® SATA controller driver installed

B. Using XHD

Select **XHD** and click **Create RAID 0** based on your need ^(Note 2).

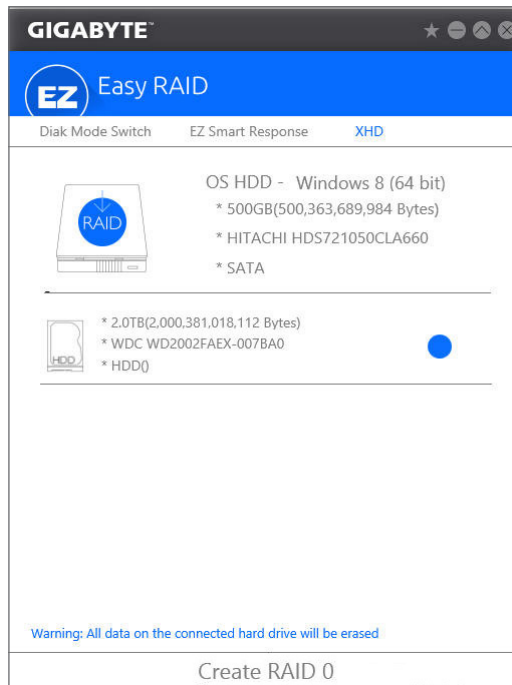

(Note 1) The XHD utility only supports the SATA connectors controlled by the Intel® Chipset.

(Note 2) Except for the operating system drive, all data on other hard drive will be deleted. Back up your data before using the XHD utility.

5-3 Smart Switch

GIGABYTE Smart Switch provides you with the conventional Windows start menu, allowing you to easily access to the apps that you frequently use. You can also select the default screen displayed after you enter Windows.

The Smart Switch Interface

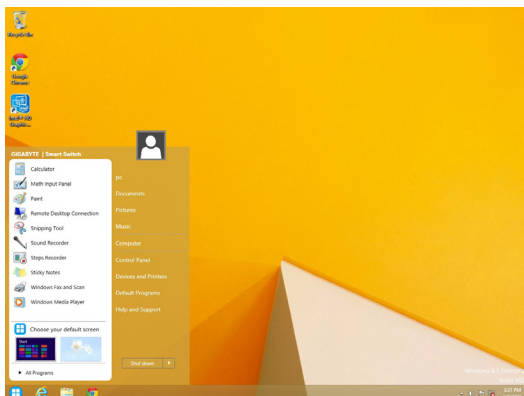

Using Smart Switch

The Smart Switch icon  will appear on the bottom left corner of the traditional Windows desktop screen after Smart Switch is installed. Left-click the icon to see the screen as that shown above and you can set the default screen displayed after you enter Windows.

Chapter 6 Appendix

6-1 Configuring Audio Input and Output

6-1-1 Configuring 2/4/5.1/7.1-Channel Audio

The motherboard provides five audio jacks on the back panel which support 2/4/5.1/7.1-channel ^(Note) audio. The picture to the right shows the default audio jack assignments.



- To configure 4/5.1/7.1-channel audio, you have to retask either the Line in or Mic in jack to be Side speaker out through the audio driver.
- Audio signals will be present on both of the front and back panel audio connections simultaneously. If you want to mute the back panel audio (only supported when using an HD front panel audio module), refer to instructions on the next page.

High Definition Audio (HD Audio)

HD Audio includes multiple high quality digital-to-analog converters (DACs) and features multistreaming capabilities that allow multiple audio streams (in and out) to be simultaneously processed. For example, users can listen to MP3 music, have an Internet chat, make a telephone call over the Internet, and etc. all at the same time.

A. Configuring Speakers

(The following instructions use Windows 8.1 as the example operating system.)

Step 1:

After installing the audio driver, restart your computer. Then switch to Windows desktop mode. The **HD Audio Manager** icon  will appear in the notification area. Double-click the icon to access the **HD Audio Manager**.

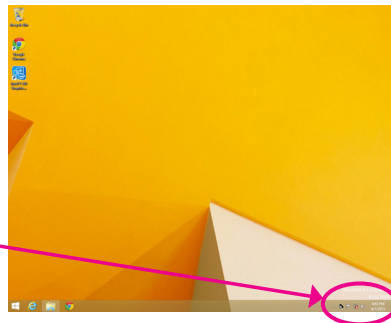

(Note) 2/4/5.1/7.1-Channel Audio Configurations:

Refer to the following for multi-channel speaker configurations.

- 2-channel audio: Headphone or Line out.
- 4-channel audio: Front speaker out and Rear speaker out.
- 5.1-channel audio: Front speaker out, Rear speaker out, and Center/Subwoofer speaker out.
- 7.1-channel audio: Front speaker out, Rear speaker out, Center/Subwoofer speaker out, and Side speaker out.

Step 2:

Connect an audio device to an audio jack. The **The current connected device is** dialog box appears. Select the device according to the type of device you connect. Then click **OK**.



Step 3:

On the **Speakers** screen, click the **Speaker Configuration** tab. In the **Speaker Configuration** list, select **Stereo**, **Quadraphonic**, **5.1 Speaker**, or **7.1 Speaker** according to the type of speaker configuration you wish to set up. Then the speaker setup is completed.

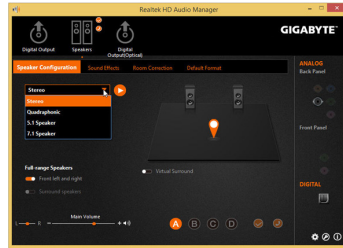

B. Configuring Sound Effect

You may configure an audio environment on the **Sound Effects** tab.

C. Activating an AC'97 Front Panel Audio Module

If your chassis provides an AC'97 front panel audio module, to activate the AC'97 functionality, click the **Tool** icon  on the right bottom of the screen. On the **Connector Settings** dialog box, select the **Disable front panel jack detection** check box. Click **OK** to complete.

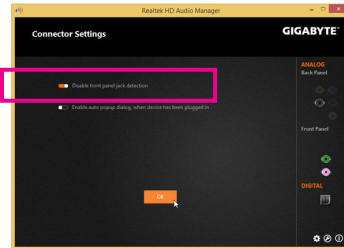

D. Muting the Back Panel Audio (For HD Audio Only)

Click **Device advanced settings** icon  on the right bottom of the screen to open the **Device advanced settings** dialog box. Select the **Mute the rear output device, when a front headphone plugged in** check box. Click **OK** to complete.

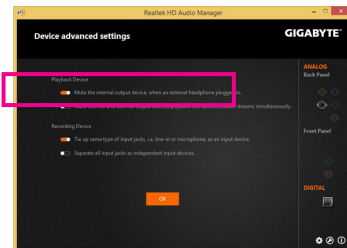

6-1-2 Configuring S/PDIF Out

The S/PDIF Out jack can transmit audio signals to an external decoder for decoding to get the best audio quality.

1. Connecting a S/PDIF Out Cable:

Connect a S/PDIF optical cable to an external decoder for transmitting the S/PDIF digital audio signals.

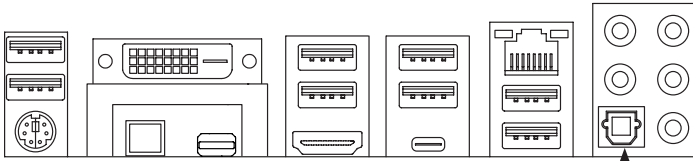

Connects to a S/PDIF optical cable

2. Configuring S/PDIF Out:

On the **Digital Output(Optical)** screen ^(Note), click the **Default Format** tab and then select the sample rate and bit depth. Click **OK** to complete.

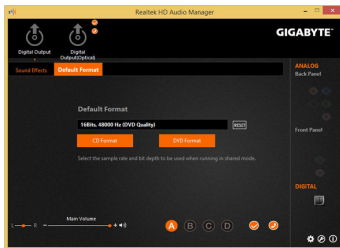

(Note) Enter the **Digital Output(Optical)** screen to configure further settings if you use the S/PDIF Out connector(s) on the back panel for digital audio output or enter the **Digital Output** screen if you use the internal S/PDIF Out connector (SPDIF_O) for digital audio output.

6-1-3 Configuring Microphone Recording

Step 1:

Switch to Windows desktop mode. The **HD Audio Manager** icon will appear in the notification area. Double-click the icon to access the **HD Audio Manager**.

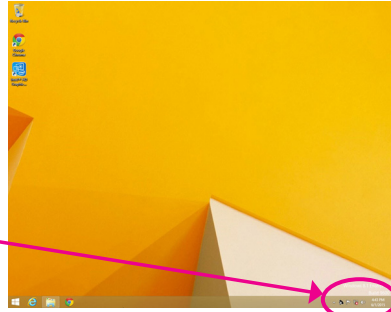

Step 2:

Connect your microphone to the Mic in jack (pink) on the back panel or the Mic in jack (pink) on the front panel. Then configure the jack for microphone functionality. Note: The microphone functions on the front panel and back panel cannot be used at the same time.

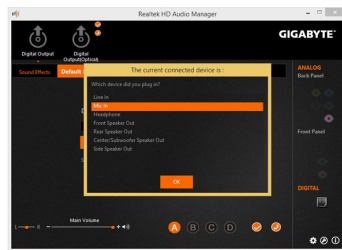

Step 3:

Go to the **Microphone** screen. Do not mute the recording volume, or you'll not be able to record the sound. To hear the sound being recorded during the recording process, do not mute the playback volume. It is recommended that you set the volumes at a middle level.



Step 4:

To raise the recording and playback volume for the microphone, you can set the Microphone Boost level on the right of the **Recording Volume** slider.



Step 5:

To open the **Sound Recorder**, move the mouse cursor to the bottom left corner of the screen, click the **Start** icon to switch to the **Start** screen (or press the Windows button on the keyboard). Click the **Start** icon on the bottom left corner of the screen to access the **Apps** screen.

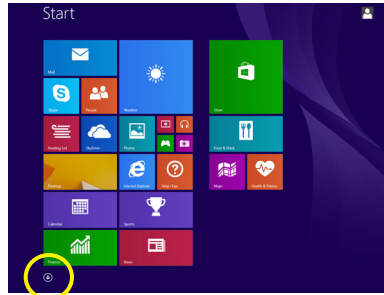

Step 6:

On this screen, click **Sound Recorder** for audio recording.

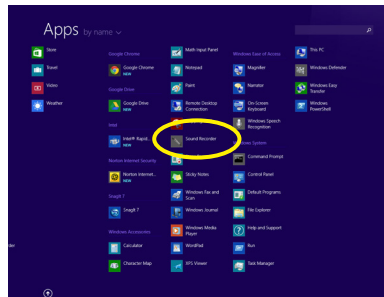

* Enabling Stereo Mix

If the HD Audio Manager does not display the recording device you wish to use, refer to the steps below. The following steps explain how to enable Stereo Mix (which may be needed when you want to record sound from your computer).

Step 1:

Switch to Windows desktop mode. Locate the **Speaker** icon in the notification area and right-click on this icon. Select **Recording Devices**.

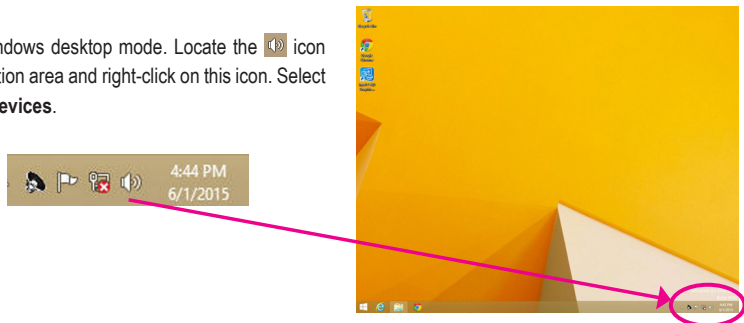

Step 2:

On the **Recording** tab, right-click on an empty space and select **Show Disabled Devices**.

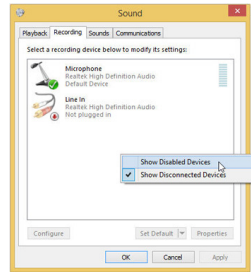

Step 3:

When the **Stereo Mix** item appears, right-click on this item and select **Enable**. Then set it as the default device.

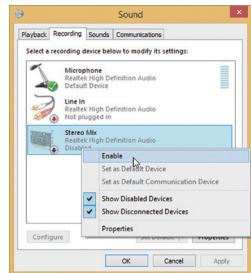

Step 4:

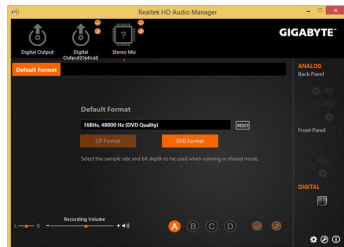

Now you can access the **HD Audio Manager** to configure **Stereo Mix** and use **Sound Recorder** to record the sound.

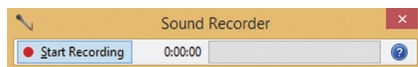

6-1-4 Using the Sound Recorder



A. Recording Sound

1. Make sure you have connected the sound input device (e.g. microphone) to the computer.
2. To record the audio, click the **Start Recording** button .
3. To stop recording audio, click the **Stop Recording** button .

Be sure to save the recorded audio file upon completion.

B. Playing the Recorded Sound

You can play your recording in a digital media player program that supports your audio file format.

6-2 Troubleshooting

6-2-1 Frequently Asked Questions

To read more FAQs for your motherboard, please go to the **Support & Downloads\FAQ** page on GIGABYTE's website.

Q: Why is the light of my keyboard/optical mouse still on after the computer shuts down?

A: Some motherboards provide a small amount of standby power after the computer shuts down and that's why the light is still on.

Q: How do I clear the CMOS values?

A: For motherboards that have a Clear CMOS button, press this button to clear the CMOS values (before doing this, please turn off the computer and unplug the power cord). For motherboards that have a Clear CMOS jumper, refer to the instructions in Chapter 1 to short the jumper to clear the CMOS values. If your board doesn't have this jumper/button, refer to the instructions on the motherboard battery in Chapter 1. You can temporarily remove the battery from the battery holder to stop supplying power to the CMOS, which will clear the CMOS values after about one minute.

Q: Why do I still get a weak sound even though I have turned my speaker to the maximum volume?

A: Make sure your speaker is equipped with an internal amplifier. If not, try a speaker with power/amplifier.

6-2-2 Troubleshooting Procedure

If you encounter any troubles during system startup, follow the troubleshooting procedure below to solve the problem.

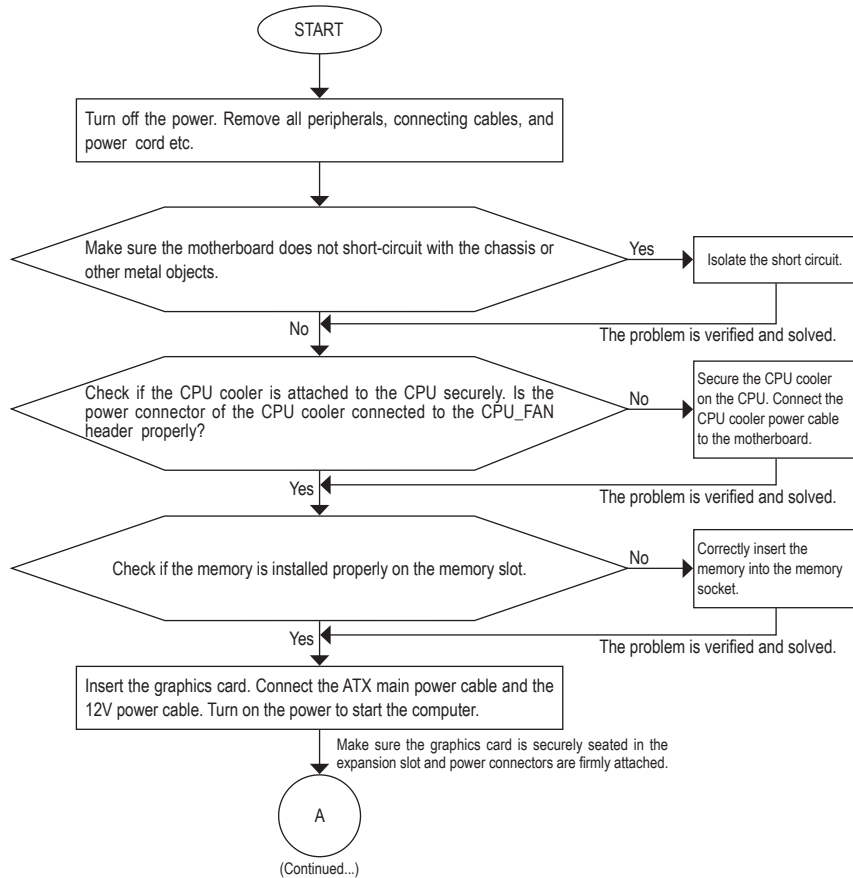

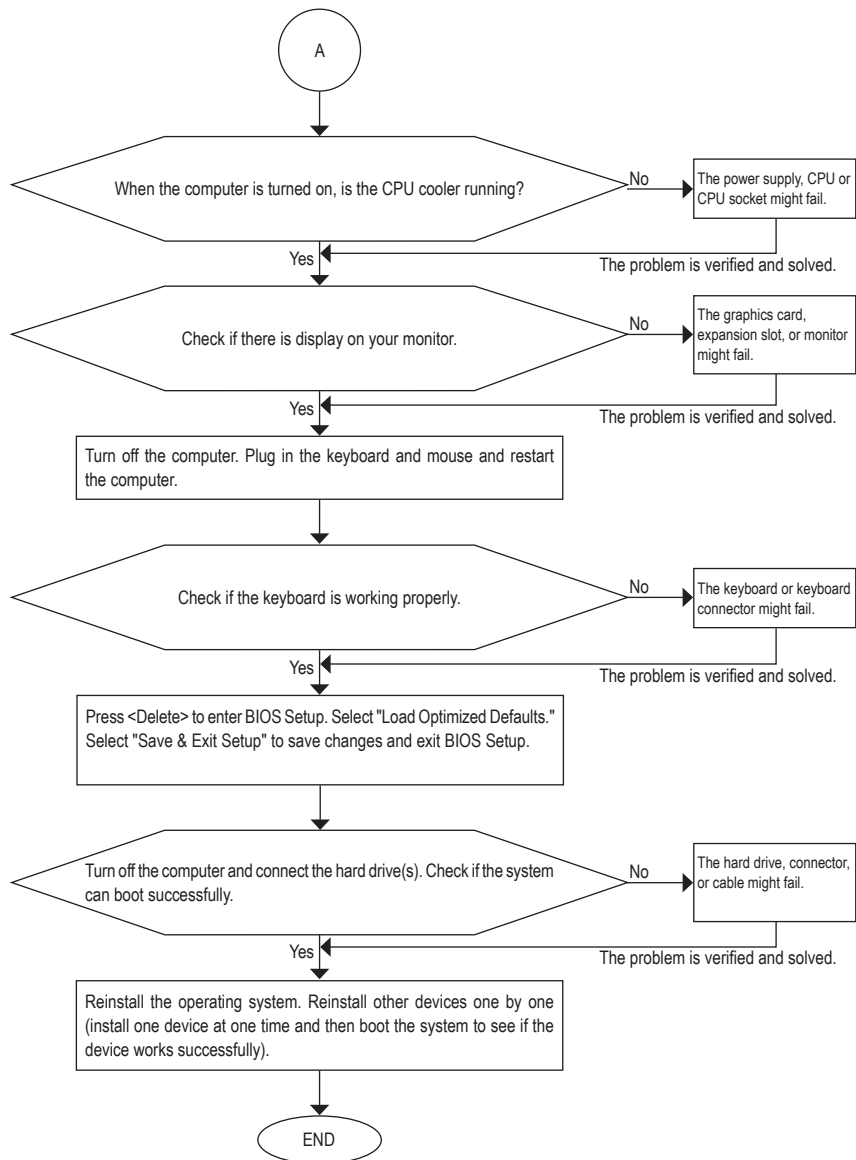

If the procedure above is unable to solve your problem, contact the place of purchase or local dealer for help. Or go to the **Support** **Technical Support** page to submit your question. Our customer service staff will reply you as soon as possible.

6-3 Debug LED Codes

Regular Boot

Code	Description
10	PEI Core is started.
11	Pre-memory CPU initialization is started.
12~14	Reserved.
15	Pre-memory North-Bridge initialization is started.
16~18	Reserved.
19	Pre-memory South-Bridge initialization is started.
1A~2A	Reserved.
2B~2F	Memory initialization.
31	Memory installed.
32~36	CPU PEI initialization.
37~3A	IOH PEI initialization.
3B~3E	PCH PEI initialization.
3F~4F	Reserved.
60	DXE Core is started.
61	NVRAM initialization.
62	Installation of the PCH runtime services.
63~67	CPU DXE initialization is started.
68	PCI host bridge initialization is started.
69	IOH DXE initialization.
6A	IOH SMM initialization.
6B~6F	Reserved.
70	PCH DXE initialization.
71	PCH SMM initialization.
72	PCH devices initialization.
73~77	PCH DXE initialization (PCH module specific).
78	ACPI Core initialization.
79	CSM initialization is started.
7A~7F	Reserved for AML use.
80~8F	Reserved for OEM use (OEM DXE initialization codes).
90	Phase transfer to BDS (Boot Device Selection) from DXE.
91	Issue event to connect drivers.

Code	Description
92	PCI Bus initialization is started.
93	PCI Bus hot plug initialization.
94	PCI Bus enumeration for detecting how many resources are requested.
95	Check PCI device requested resources.
96	Assign PCI device resources.
97	Console Output devices connect (ex. Monitor is lighted).
98	Console input devices connect (ex. PS2/USB keyboard/mouse are activated).
99	Super IO initialization.
9A	USB initialization is started.
9B	Issue reset during USB initialization process.
9C	Detect and install all currently connected USB devices.
9D	Activated all currently connected USB devices.
9E~9F	Reserved.
A0	IDE initialization is started.
A1	Issue reset during IDE initialization process.
A2	Detect and install all currently connected IDE devices.
A3	Activated all currently connected IDE devices.
A4	SCSI initialization is started.
A5	Issue reset during SCSI initialization process.
A6	Detect and install all currently connected SCSI devices.
A7	Activated all currently connected SCSI devices.
A8	Verify password if needed.
A9	BIOS Setup is started.
AA	Reserved.
AB	Wait user command in BIOS Setup.
AC	Reserved.
AD	Issue Ready To Boot event for OS Boot.
AE	Boot to Legacy OS.
AF	Exit Boot Services.
B0	Runtime AP installation begins.
B1	Runtime AP installation ends.
B2	Legacy Option ROM initialization.
B3	System reset if needed.

Code	Description
B4	USB device hot plug-in.
B5	PCI device hot plug.
B6	Clean-up of NVRAM.
B7	Reconfigure NVRAM settings.
B8~BF	Reserved.
C0~CF	Reserved.

S3 Resume

Code	Description
E0	S3 Resume is started (called from DXE IPL).
E1	Fill boot script data for S3 resume.
E2	Initializes VGA for S3 resume.
E3	OS S3 wake vector call.

Recovery

Code	Description
F0	Recovery mode will be triggered due to invalid firmware volume detection.
F1	Recovery mode will be triggered by user decision.
F2	Recovery is started.
F3	Recovery firmware image is found.
F4	Recovery firmware image is loaded.
F5~F7	Reserved for future AMI progress codes.

Error

Code	Description
50~55	Memory initialization error occurs.
56	Invalid CPU type or speed.
57	CPU mismatch.
58	CPU self test failed or possible CPU cache error.
59	CPU micro-code is not found or micro-code update is failed.
5A	Internal CPU error.
5B	Reset PPI is failed.
5C~5F	Reserved.
D0	CPU initialization error.
D1	IOH initialization error.

Code	Description
D2	PCH initialization error.
D3	Some of the Architectural Protocols are not available.
D4	PCI resource allocation error. Out of Resources.
D5	No Space for Legacy Option ROM initialization.
D6	No Console Output Devices are found.
D7	No Console Input Devices are found.
D8	It is an invalid password.
D9~DA	Can't load Boot Option.
DB	Flash update is failed.
DC	Reset protocol is failed.
DE~DF	Reserved.
E8	S3 resume is failed.
E9	S3 Resume PPI is not found.
EA	S3 Resume Boot Script is invalid.
EB	S3 OS Wake call is failed.
EC~EF	Reserved.
F8	Recovery PPI is invalid.
F9	Recovery capsule is not found.
FA	Invalid recovery capsule.
FB~FF	Reserved.

Regulatory Statements

Regulatory Notices

This document must not be copied without our written permission, and the contents there of must not be imparted to a third party nor be used for any unauthorized purpose. Contravention will be prosecuted. We believe that the information contained herein was accurate in all respects at the time of printing. GIGABYTE cannot, however, assume any responsibility for errors or omissions in this text. Also note that the information in this document is subject to change without notice and should not be construed as a commitment by GIGABYTE.

Our Commitment to Preserving the Environment

In addition to high-efficiency performance, all GIGABYTE motherboards fulfill European Union regulations for RoHS (Restriction of Certain Hazardous Substances in Electrical and Electronic Equipment) and WEEE (Waste Electrical and Electronic Equipment) environmental directives, as well as most major worldwide safety requirements. To prevent releases of harmful substances into the environment and to maximize the use of our natural resources, GIGABYTE provides the following information on how you can responsibly recycle or reuse most of the materials in your "end of life" product.

Restriction of Hazardous Substances (RoHS) Directive Statement

GIGABYTE products have not intended to add and safe from hazardous substances (Cd, Pb, Hg, Cr+6, PBDE and PBB). The parts and components have been carefully selected to meet RoHS requirement. Moreover, we at GIGABYTE are continuing our efforts to develop products that do not use internationally banned toxic chemicals.

Waste Electrical & Electronic Equipment (WEEE) Directive Statement

GIGABYTE will fulfill the national laws as interpreted from the 2002/96/EC WEEE (Waste Electrical and Electronic Equipment) directive. The WEEE Directive specifies the treatment, collection, recycling and disposal of electric and electronic devices and their components. Under the Directive, used equipment must be marked, collected separately, and disposed of properly.

WEEE Symbol Statement



The symbol shown below is on the product or on its packaging, which indicates that this product must not be disposed of with other waste. Instead, the device should be taken to the waste collection centers for activation of the treatment, collection, recycling and disposal procedure. The separate collection and recycling of your waste equipment at the time of disposal will help to conserve natural resources and ensure that it is recycled in a manner that protects human health and the environment.

For more information about where you can drop off your waste equipment for recycling, please contact your local government office, your household waste disposal service or where you purchased the product for details of environmentally safe recycling.

- ♦ When your electrical or electronic equipment is no longer useful to you, "take it back" to your local or regional waste collection administration for recycling.
- ♦ If you need further assistance in recycling, reusing in your "end of life" product, you may contact us at the Customer Care number listed in your product's user's manual and we will be glad to help you with your effort.

Finally, we suggest that you practice other environmentally friendly actions by understanding and using the energy-saving features of this product (where applicable), recycling the inner and outer packaging (including shipping containers) this product was delivered in, and by disposing of or recycling used batteries properly. With your help, we can reduce the amount of natural resources needed to produce electrical and electronic equipment, minimize the use of landfills for the disposal of "end of life" products, and generally improve our quality of life by ensuring that potentially hazardous substances are not released into the environment and are disposed of properly.

FCC Notice (U.S.A. Only)

This equipment has been tested and found to comply with the limits for a Class B digital device, pursuant to Part 15 of the FCC Rules. These limits are designed to provide reasonable protection against harmful interference in a residential installation. This equipment generates, uses, and can radiate radio frequency energy and, if not installed and used in accordance with the instructions, may cause harmful interference to radio communications. However, there is no guarantee that interference will not occur in a particular installation. If this equipment does cause harmful interference to radio or television reception, which can be determined by turning the equipment off and on, the user is encouraged to try to correct the interference by one or more of the following measures:

- ◆ Reorient or relocate the receiving antenna.
- ◆ Increase the separation between the equipment and receiver.
- ◆ Connect the equipment into an outlet on a circuit different from that to which the receiver is connected.
- ◆ Consult a dealer or experienced TV/radio technician for help.

Canada, Industry Canada (IC) Notices / Canada, avis d'Industry Canada (IC)

- ◆ This Class B digital apparatus complies with Canadian ICES-003 and RSS-210.
- ◆ Operation is subject to the following two conditions: (1) this device may not cause interference, and (2) this device must accept any interference, including interference that may cause undesired operation of the device.
- ◆ Cet appareil numérique de classe B est conforme aux normes canadiennes ICES-003 et RSS-210.
- ◆ Son fonctionnement est soumis aux deux conditions suivantes : (1) cet appareil ne doit pas causer d'interférence et (2) cet appareil doit accepter toute interférence, notamment les interférences qui peuvent affecter son fonctionnement.



Contact Us

- **GIGA-BYTE TECHNOLOGY CO., LTD.**

Address: No.6, Baoqiang Rd., Xindian Dist.,
New Taipei City 231, Taiwan
TEL: +886-2-8912-4000
FAX: +886-2-8912-4005
Tech. and Non-Tech. Support (Sales/Marketing) :
<http://esupport.gigabyte.com>
WEB address (English): <http://www.gigabyte.com>
WEB address (Chinese): <http://www.gigabyte.tw>

- **G.B.T. INC. - U.S.A.**

TEL: +1-626-854-9338
FAX: +1-626-854-9326
Tech. Support: <http://esupport.gigabyte.com>
Warranty Info: <http://rma.gigabyte.us>
Web address: <http://www.gigabyte.us>

- **G.B.T. INC (USA) - Mexico**

Tel: +1-626-854-9338 x 215 (Soporte de habla hispano)
FAX: +1-626-854-9326
Correo: soporte@gigabyte-usa.com
Tech. Support: <http://rma.gigabyte.us>
Web address: <http://latam.giga-byte.com>

- **Giga-Byte SINGAPORE PTE. LTD. - Singapore**

WEB address : <http://www.gigabyte.sg>

- **Thailand**

WEB address : <http://th.giga-byte.com>

- **Vietnam**

WEB address : <http://www.gigabyte.vn>

- **NINGBO G.B.T. TECH. TRADING CO., LTD. - China**

WEB address : <http://www.gigabyte.cn>

- **Shanghai**

TEL: +86-21-63400912
FAX: +86-21-63400682

- **Beijing**

TEL: +86-10-62102838
FAX: +86-10-62102848

- **Wuhan**

TEL: +86-27-87685981
FAX: +86-27-87579461

- **GuangZhou**

TEL: +86-20-87540700
FAX: +86-20-87544306

- **Chengdu**

TEL: +86-28-85483135
FAX: +86-28-85256822

- **Xian**

TEL: +86-29-85531943
FAX: +86-29-85510930

- **Shenyang**

TEL: +86-24-83992342
FAX: +86-24-83992102

- **GIGABYTE TECHNOLOGY (INDIA) LIMITED - India**

WEB address : <http://www.gigabyte.in>

- **Saudi Arabia**

WEB address : <http://www.gigabyte.com.sa>

- **Gigabyte Technology Pty. Ltd. - Australia**

WEB address : <http://www.gigabyte.com.au>

- **G.B.T. TECHNOLOGY TRADING GMBH - Germany**

WEB address : <http://www.gigabyte.de>

- **G.B.T. TECH. CO., LTD. - U.K.**

WEB address : <http://www.giga-byte.co.uk>

- **Giga-Byte Technology B.V. - The Netherlands**

WEB address : <http://www.giga-byte.nl>

- **GIGABYTE TECHNOLOGY FRANCE - France**

WEB address : <http://www.gigabyte.fr>

- **Sweden**

WEB address : <http://www.gigabyte.se>

- **Italy**

WEB address : <http://www.giga-byte.it>

- **Spain**

WEB address : <http://www.giga-byte.es>

- **Greece**

WEB address : <http://www.gigabyte.com.gr>

- **Czech Republic**

WEB address : <http://www.gigabyte.cz>

- **Hungary**

WEB address : <http://www.giga-byte.hu>

- **Turkey**

WEB address : <http://www.gigabyte.com.tr>

- **Russia**

WEB address : <http://www.gigabyte.ru>

- **Poland**

WEB address : <http://www.gigabyte.pl>

- **Ukraine**

WEB address : <http://www.gigabyte.ua>

- **Romania**

WEB address : <http://www.gigabyte.com.ro>

- **Serbia**

WEB address : <http://www.gigabyte.co.rs>

- **Kazakhstan**

WEB address : <http://www.gigabyte.kz>

You may go to the GIGABYTE website, select your language in the language list on the top right corner of the website.

- **GIGABYTE eSupport**

To submit a technical or non-technical (Sales/Marketing) question, please link to:

<http://esupport.gigabyte.com>

